

INTARCO

REFRIGERATION UNITS COMMERCIAL RANGE



Price list
2021
update 01 July 2021

INTARCON, is a Spain-based company dedicated to designing, manufacturing, marketing and servicing a full range of refrigeration equipment for commercial and industrial sectors.

Our mission at INTARCON is to develop and offer the market a wide range of innovative solutions for the most reliable, efficient and sustainable operation of refrigeration facilities.

The INTARCON team has over 30 years of valuable experience in the fields of refrigeration, air conditioning and related thermal appliances, focusing our effort on the creation and development of a wide range of innovative refrigeration solutions.



ATHENAEUM LIBRARY
BARCELONA, SPAIN



INETAB-KAUBECK TOBACCO
DOMINICAN REPUBLIC



CAPITANIA GENERAL
SEVILLE, SPAIN



CONGRESS PALACE
MAJORCA, SPAIN



JOHNNY ROCKETS
ABU DHABI



UNIVERSITY HOSPITAL
SALAMANCA, SPAIN



ALDI SUPERMARKET
PORTUGAL



GROUPE BÉGANTON
FRANCE



DELINOVA
CURAÇAO

more than
50 000
supplied units

at more than
50
countries

with more than
200
employees

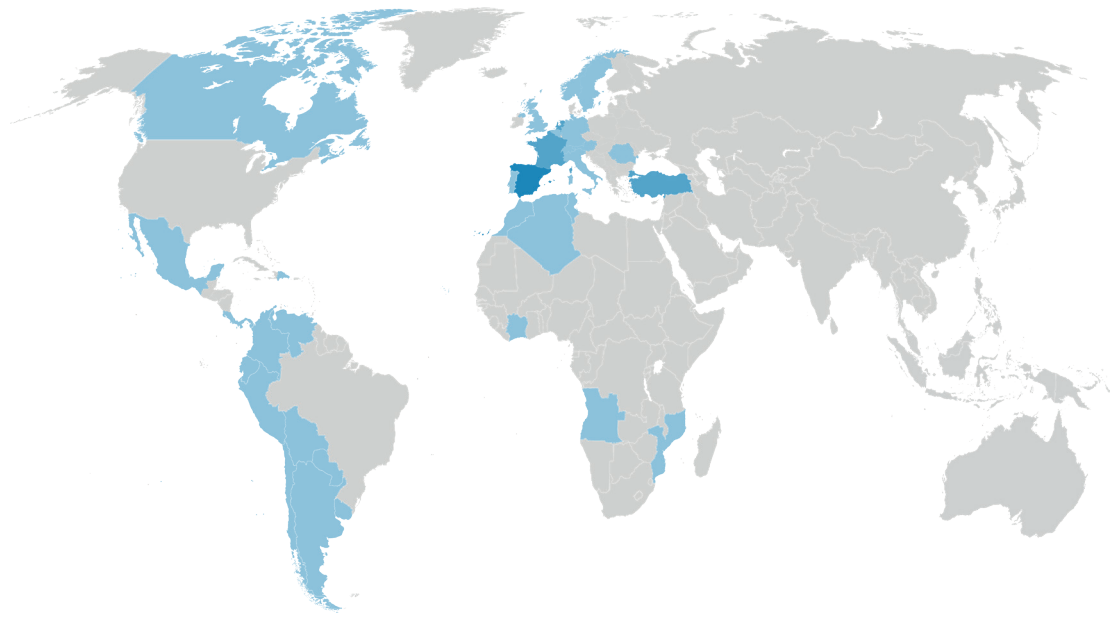

Europe

- Germany
- Austria
- Belgium
- Spain
- France
- Italy
- Ireland
- Norway
- Netherlands
- Portugal
- United Kingdom
- Romania
- Sweden
- Switzerland
- Turkey

America

- Argentina
- Bolivia
- Canada
- Chile
- Colombia
- Costa Rica
- Dominican Rep.
- Ecuador
- Mexico
- Panama
- Paraguay
- Peru
- Uruguay
- Venezuela

Africa

- Angola
- Equatorial Africa
- Algeria
- Cape Verde
- Ivory Coast
- Morocco
- Mozambique
- Tunisia

WHAT'S NEW IN COMMERCIAL RANGE 2021

New R-290 monoblock units



New compact units with high-efficiency R-290 refrigerant in our known construction of door monoblock for the cold room, with very low refrigerant charge.

New CR3 models of rooftop monoblocks



We have expanded our range of compact units with new models of larger ceiling units, with axial or centrifugal condensation, for positive cold rooms up to 50 m³ and negative cold rooms up to 25 m³.

R-290 Waterloo motoevaporators



An evaporator with built-in group? This is the 100 % natural innovative solution that INTARCON proposes for cold rooms. Discover the new R-290 Waterloo series.

Smartest electronic regulation



A new electronic control unit that ensures the safety of the cold room, the environment and the installation, with predictive self-diagnosis, gas collection manoeuvre, and synchronization with other units.

New improved models 55 and 75 at negative temperature



We have upgraded our compact and split low-temperature models to the new Tecumseh FH2 compressors, which are quieter, with higher cooling capacity and lower energy consumption.

Low refrigerant charge units



We update our range of single-phase split systems to reduce the refrigerant charge, with pre-charging up to 10 m of refrigeration lines, equivalent to less than 5 ton CO₂, and are exempt from leak checks.

Commercial monoblocks

- * Slim monoblocks for small cold rooms.
- * Easy Plug & Play installation directly on the ceiling, door or wall of the cold room.
- * R-290 ecological refrigerant.



Commercial split systems

- * Split system for small and medium sized cold rooms.
- * Refrigerant pre-load and exempt from leak checks.
- * R-134a and R-449A refrigerant with low greenhouse effect.
- * Low noise and relative condensation.



Special applications

- * Meat preservation and maturation.
- * High humidity conservation applications.
- * Wine cellar units with external vapour humidification kit.



Condensing units

- * Tropicalised design, low noise and centrifugal fan.
- * Ecodesign certification.
- * Electronic and multi-service controller versions.



intarSANIT

- * Air purification and sterilization in work rooms.
- * High efficiency filtration units.
- * Air renewal units with active cold recovery.



Waterloop system

- * R-290 water condensed motor evaporators.
- * Units condensed by water up to 50 °C.
- * Air coolers with hydraulic group.



Commercial product range

Industrial monoblock

- ❖ Hermetic piston and scroll compressors.
- ❖ High, medium, negative temperature, high relative humidity and bi-temperature.
- ❖ Easy wall installation.
- ❖ Tropicalised design for ambient temperature up to 45 °C.



Evaporating units and air coolers

- ❖ Units equipped with expansion and control valves.
- ❖ Optimized designs for R-134a, R-449A and glycol.
- ❖ High, medium, negative temperature and deep freezing.



Compact air-cooled DX plants up to 40 kW

- ❖ Compact plant with axial or centrifugal condenser.
- ❖ Duo/trio reciprocating or scroll compressors.
- ❖ Optimized designs for each refrigerant (R-134a, R-449A).



Air-cooled glycol chillers

- ❖ Operation with glycol water and reduced R-290 refrigerant charge.
- ❖ Hermetic piston, scroll and semi-hermetic compressors.
- ❖ Included hydraulic group.



CO₂ system from 30 up to 60 kW

- ❖ Compact plants with axial or centrifugal gas-cooler.
- ❖ Compressors trio at PT and compressors duo at NT.
- ❖ High performance with parallel compression.



NH₃ chillers - ammolite

- ❖ Low charge ammonia technology.
- ❖ Dry expansion systems.
- ❖ Air-cooled chillers.



Industrial product range



Headquarters

P.I. Los Santos, Bulevar de Los Santos 34
14900 Lucena (Córdoba) Spain
+34 957 50 92 93

Spain sales

comercial@intarcon.com

International sales

commercial@intarcon.com

Service

service@intarcon.com

Europe | europe@intarcon.com

Austria | osterreich@intarcon.com

Belgium | belgique@intarcon.com

France | france@intarcon.com

Germany | deutschland@intarcon.com

Ireland | ireland@intarcon.com

Italy | italy@intarcon.com

Netherlands | kantor@intarcon.com

Norway | norway@intarcon.com

Portugal | portugal@intarcon.com

Romania | romania@intarcon.com

Spain | comercial@intarcon.com

Sweden | sweden@intarcon.com

Switzerland | suisse@intarcon.com

Turkey | turkiye@intarcon.com

United Kingdom | uk@intarcon.com

America | latam@intarcon.com

Argentina | argentina@intarcon.com

Bolivia | bolivia@intarcon.com

Canada | canada@intarcon.com

Chile | chile@intarcon.com

Colombia | colombia@intarcon.com

Costa Rica | costarica@intarcon.com

Dominican Rep. | repdominicana@intarcon.com

Ecuador | ecuador@intarcon.com

Mexico | mexico@intarcon.com

Panama | panama@intarcon.com

Paraguay | paraguay@intarcon.com

Peru | peru@intarcon.com

Uruguay | uruguay@intarcon.com

Venezuela | venezuela@intarcon.com

Africa | africa@intarcon.com

Algeria | algerie@intarcon.com

Angola | angola@intarcon.com

Equatorial Africa | afrique.equatoriale@intarcon.com

Cape Verde | caboverde@intarcon.com

Ivory Coast | cotedivoire@intarcon.com

Morocco | maroc@intarcon.com

Mozambique | mozambique@intarcon.com

Tunisia | tunisia@intarcon.com

“ Maximum quality
in our products and
excellence in our
services ”



www.intarcon.com



TÜVRheinland®



Product codification

INTARCON units are identified unequivocally according to the following criteria in their nomenclature:

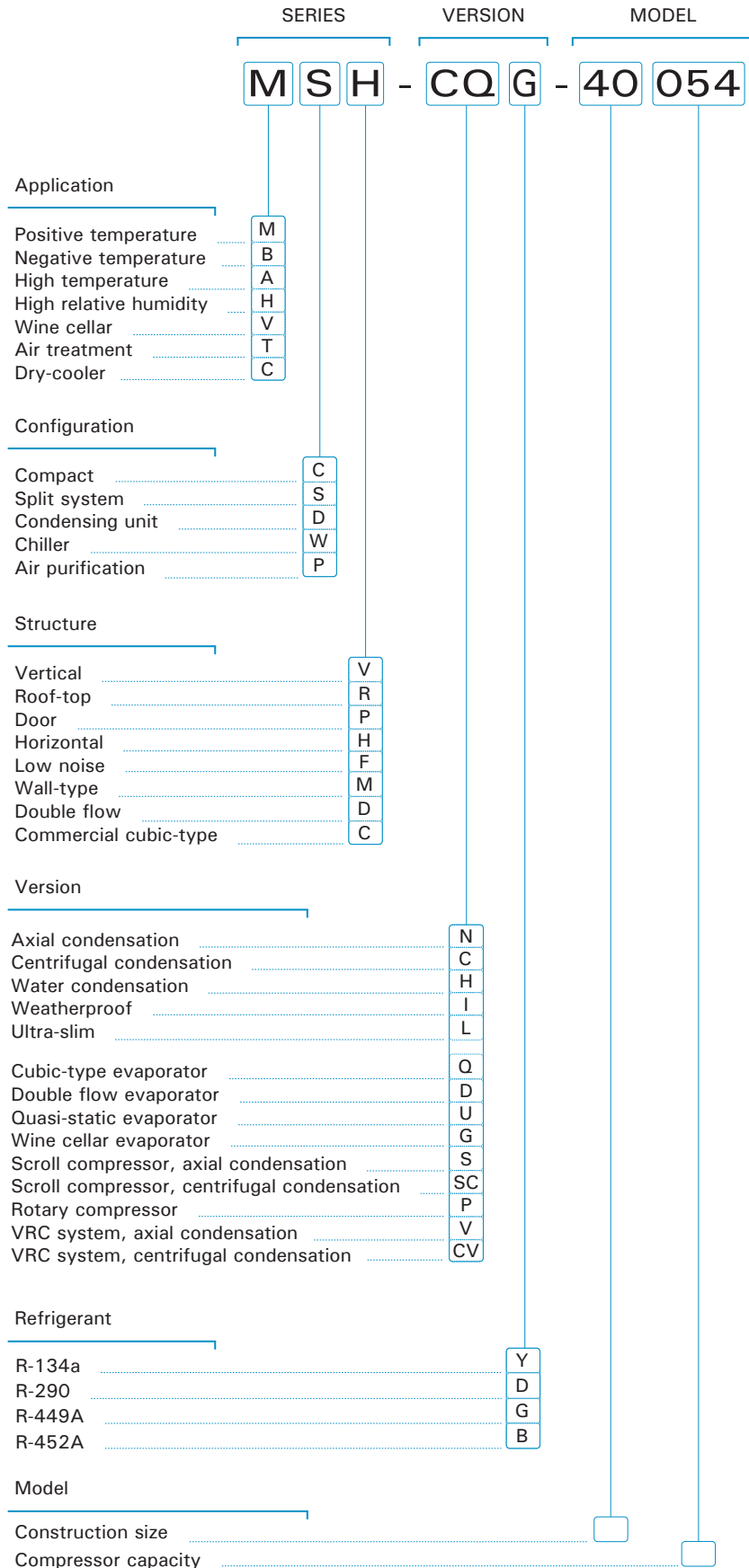

Index

Commercial range	4
Industrial range	5
Sales network	6
Product codification	7
Cold room calculation	8
Cooling calculator	8
Monoblocks	9
MCP -N / BCP -N	11
MCR -N / BCR -N	13
MCR -C / BCR -C	13
MCV -LD / BCV -LD	15
MCV -N / BCV -N	17
MCV -C / BCV -C	17
MCV -I / BCV -I	18
Split systems	19
Horizontal, axial and centrifugal	
MSH -N / BSH -N	21
MSH -C / BSH -C	21
MSH -Q / BSH -Q	22
MSH -CO / BSH -CO	22
ASH -D	23
ASH -CD	23
Low noise	
MSF -N / BSF -N	25
MSF -Q / BSF -Q	26
ASF -D	27
Meat units	
MSF -U	29
MSH -CU	29
High relative humidity	
HSF -D	31
HSH -CD	31
Wine cellar units	
VSF -G	33
VSH -CG	33
VCR -N / VCR -C	34
intarSANIT	35
TCH	36
TPD	37
Waterloop system	39
MCC -N/S / BCC -N/S	43
MDM -P/S / BDM -P/S	45
CWF	46
Condensing units	47
MDF -N / BDF -N	49
MDH -N / BDH -N	52
MDH -C / BDH -C	52
VRC	54
Cooling connection	55
Electronic regulation	56
kiconex	57
Transport package dimensions	58
Sales terms	59

Cold room calculation

Quick needs calculation

The chart below shows recommended cooling needs for high temperature process rooms and cold rooms at positive and negative temperature according to the calculation basis.

Cold room volume (m ³)	Recommended cooling needs for standard process handling rooms and cold storage rooms (W)					
	HIGH TEMPERATURE (12 °C)		POSITIVE TEMPERATURE (0 °C)		NEGATIVE TEMPERATURE (-20 °C)	
	No floor panel	Floor panel	No floor panel	Floor panel		
	50 mm insulation	Without insulation	80 mm insulation	100 mm insulation		
Commercial cold rooms	5		700	900	700	
	10	1 300	2 300	1 200	1 500	1 100
	15	1 600	2 700	1 600	2 000	1 400
	20	1 900	3 400	1 900	2 400	1 700
	25	2 300	4 000	2 300	2 800	2 000
	30	2 600	4 500	2 600	3 300	2 200
	40	3 200	5 600	3 200	4 000	2 700
	50	3 800	6 600	3 800	4 800	3 100
	60	4 400	7 600	4 400	5 400	3 600
	75	5 100	9 000	5 100	6 400	4 200
	100	6 400	11 100	6 400	8 000	5 100
	125	7 500	13 100	7 500	9 400	5 900
	150	8 600	15 100	8 600	10 800	6 700
	175	9 700	16 900	9 700	12 100	7 500
	200	10 700	18 700	10 700	13 300	8 200
	250	12 600	22 100	12 600	15 800	9 600

Unit capacity correction

Cooling capacity indicated in this catalogue are based on the cooling performance of the unit with 35 °C ambient temperature.

To obtain cooling capacity of the unit under other ambient temperature values it is recommended to apply the following correction factors:

AMBIENT TEMPERATURE		20 °C	25 °C	30 °C	35 °C	40 °C	45 °C
PT	F _a : Cooling capacity factor	1.23	1.15	1.08	1.00	0.92	0.84
	F _b : Input power factor	0.81	0.88	0.94	1.00	1.07	1.13
NT	F _a : Cooling capacity factor	1.33	1.22	1.11	1.00	0.89	0.77
	F _b : Input power factor	0.85	0.91	0.96	1.00	1.03	1.05

$$\text{Cooling capacity} = F_a \times \text{Cooling capacity}_{|35\text{ °C}}$$

$$\text{Input power} = F_b \times \text{Input power}_{|35\text{ °C}}$$

$$\text{Cooling capacity}_{|35\text{ °C}} = \frac{Q_{\text{Cooling capacity, corrected}}}{F_a}$$

Online refrigeration calculator

For a more accurate calculation we recommend the use of our on-line refrigeration calculator, available on our web site.

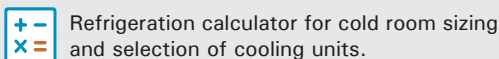

Refrigeration calculator for cold room sizing and selection of cooling units.

By entering basic design data, such as cold room type, application, dimensions and insulation thickness, you will get a quick estimation based on other standard assumptions. You will also be able to customise your calculation by entering further data and to select the most suitable refrigeration unit according to your needs.

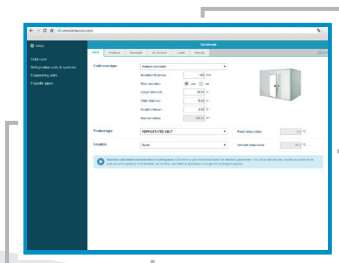

www.intarcon.com/calcooling



Correction of refrigeration needs

To obtain the corrected cooling load for a cold room with special characteristics, the application of a series of correction factors is proposed, based on the following:

$$Q_{\text{Cooling capacity corrected}} =$$

$$Q_{\text{Cooling capacity}} \times F_1 \times F_2 \times F_3 \times F_4$$

Where correction factors adopt the following values:

F1: Ambient temperature

The following correction factors can be used to obtain the cooling load at an ambient temperature other than the calculation temperature of 35 °C:

- Ambient temperature of 40 °C: **F1 = 1.05**
- Ambient temperature of 45 °C: **F1 = 1.10**

F2: Breathing of fruit and vegetable products

The ripening process of fruit and vegetable products in positive temperature storage produces a considerable amount of heat. This breathing heat can represent, depending on the type of product, up to 50 % additional cooling load.

For indicative purposes, we suggest a factor:

$$F_2 = 1,25$$

F3: High product turnover rate

The cooling capacities indicated in the table have been obtained with a conventional product rotation, according to calculation basis. A high product turnover of twice the rotation rate considered can represent up to an additional 50 % of refrigeration needs.

$$F_3 = 1,50$$

Calculation example

Calculation of an 80 m³ apple conservation cold room, isolated with an 80 mm thickness refrigeration panel, with uninsulated floor:

1. From the values in the table, the reference refrigeration load for 80 m³ is interpolated.

$$Q_{\text{cooling capacity}} = 7 200 \text{ W}$$

2. The correction factor for the heat of respiration of fruit and vegetable products is applied: **F2 = 1.25**

$$Q_{\text{cooling capacity corrected}} =$$

$$Q_{\text{cooling capacity}} \times 1.25 = 9 000 \text{ W}$$

Cooling needs calculation basis for cooling needs

Cooling needs shown for each cold room volume in product technical features charts in this catalogue have been calculated according to the following assumptions:

- Ambient temperature: 35 °C.
- Product load density: 250 kg/m³.
- Daily rotation rate depending on cold room volume: 10 % (V ≤ 100 m³), 8 % (100 m³ < V).
- Product specific heat PT: 3,2 kJ/(kg·K), NT: 1,8 kJ/(kg·K).
- Product inlet temperature: 25 °C (PT) and -5 °C (NT).
- Insulation panel: Injected polyurethane with 40 kg/m³ density and 0,025 W/(m·K) conductivity, with 80 mm (PT) and 100 mm (NT) thick and floor panel.
- 18 daily hours compressor operation time.



Commercial monoblocks

Compact refrigeration units for wall, door or roof-top installation



Easy and quick installation



100 % natural solution



R-290 low refrigerant charge

door intarblock



Commercial monoblock for refrigeration and freezing cold rooms, for assembly in the door panel of the cold room with optional R-290 refrigerant and air curtain built-in on the unit.

Features

- ▶ 230 V-I-50 Hz power supply. Available in 60 Hz. Others voltages by request.
- ▶ R-290 refrigerant load, below 0.1 kg.
- ▶ R-134a or R-449A refrigerant load, below 1 kg.
- ▶ Hermetic reciprocating compressor.
- ▶ High pressure switches.
- ▶ Thermostatic expansion valve.
- ▶ MCB protection.
- ▶ Hot gas defrost.
- ▶ Stainless steel drain pan.
- ▶ Evaporation of condensed water.
- ▶ Cold room LED light and door micro-switch cable.
- ▶ Door heater cable (only for BCP series).
- ▶ Multifunction electronic control.

Installation scheme with air curtain (optional)

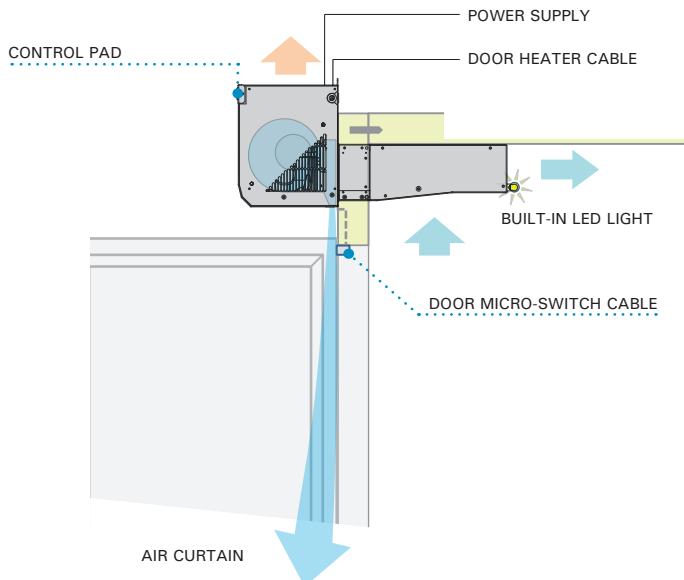

- ❄ R-290 natural refrigerant with high energy efficiency.
- ❄ Optimal use of space in mini cold rooms.
- ❄ Tropicalised design for ambient temperature up to 45 °C.
- ❄ Air curtain (optional).
- ❄ Units exempt from leak checks.

Installation



Air curtain (optional)

Door monoblock can incorporate an air curtain built-in into the unit, especially dimensioned for doors of 1 800 mm high and up to 800 mm. It has an adjustable speed centrifugal fan, door switch and linear diffuser.

Air curtain creates an invisible barrier to prevent the loss of cold inside the cold room, which is activated during the opening of the door, and prevents the entry of hot air and the loss of cold air, with an efficiency greater than 50 %.

- Centrifugal fan.
- Longitudinal air diffuser.
- Automatic activation with door opening.

Electronic control

XW60LH electronic control, as standard on our commercial propane and door monoblock units, is an advanced small size controller, which includes the following functions:



- Temperature control with maximum and minimum temperature recording.
- Quick cooling function "Jet Cool".
- Night operation mode.
- Energy saving.
- 4 output relays for: compressor, fan, defrost and light.
- 3 temperature NTC probes for cold room, defrost and condensation.

Built-in cold room LED light

High efficiency cold room LED light, built-in in the unit that is automatically activated when the cold room door is opened.

230 V-I-50 Hz | Positive temperature | R-290

Series / Model	Compressor		Cooling capacity / Cold room volume according to cold room temperature ⁽¹⁾						Input power (kW)	Max. current (A)	Evap. air flow (m ³ /h)	Refrigerant load (kg) ⁽²⁾	Weight (kg)	SPL dB(A) ⁽⁴⁾	Price (€)
	HP	Power supply	0 °C		5 °C		10 °C								
			W	m ³	W	m ³	W	m ³							
R-290 MCP-ND-0 009	1/3	230 V-I	700	6	810	8	945	13	0.34	3.1	275	< 0.1	61	29	1 981
MCP-ND-1 012	1/2	230 V-I	1 065	9	1 235	15	1 430	27	0.52	4.3	550	< 0.1	67	29	2 399
MCP-ND-1 017	3/4	230 V-I	1 325	14	1 530	20	1 765	35	0.72	4.5	550	< 0.1	67	31	2 712

230 V-I-50 Hz | Negative temperature | R-290

Series / Model	Compressor		Cooling capacity / Cold room volume according to cold room temperature ⁽¹⁾						Input power (kW)	Max. current (A)	Evap. air flow (m ³ /h)	Refrigerant load (kg) ⁽²⁾	Weight (kg)	SPL dB(A) ⁽⁴⁾	Price (€)
	HP	Power supply	-25 °C		-20 °C		-15 °C								
			W	m ³	W	m ³	W	m ³							
R-290 BCP-ND-0 014	3/4	230 V-I	420	1	500	2.5	590	5	0.30	3.3	275	< 0.1	62	29	2 305
BCP-ND-1 017	3/4	230 V-I	575	2	695	6	825	9	0.34	4.3	550	< 0.1	67	29	2 608
BCP-ND-1 028	1 1/4	230 V-I	750	4	905	9	1 070	15	0.64	6.0	550	< 0.1	74	31	2 942

230 V-I-50 Hz | Positive temperature | R-134a

Series / Model	Compressor		Cooling capacity / Cold room volume according to cold room temperature ⁽¹⁾						Input power (kW)	Max. current (A)	Evap. air flow (m ³ /h)	Refrigerant load (kg) ⁽²⁾	Weight (kg)	SPL dB(A) ⁽⁴⁾	Price (€)	Price with air curtain (€)
	HP	Power supply	0 °C		5 °C		10 °C									
			W	m ³	W	m ³	W	m ³								
R-134a MCP-NY-0 010	3/8	230 V-I	580	4	695	7	820	12	0.47	4.6	300	< 1.0	61	29	1 797	2 297
MCP-NY-0 015	1/2	230 V-I	760	7	890	10	1 030	15	0.61	5.6	300	< 1.0	66	32	2 025	2 525
MCP-NY-1 015	1/2	230 V-I	880	8	1 055	12	1 250	21	0.68	5.8	600	< 1.0	72	32	2 238	2 738
MCP-NY-1 026	3/4	230 V-I	1 180	11	1 435	18	1 710	28	0.91	9.5	600	< 1.0	79	30	2 557	3 057
MCP-NY-1 033	1	230 V-I	1 490	17	1 760	26	2 070	40	1.03	9.7	600	< 1.0	83	33	2 872	3 372

230 V-I-50 Hz | Negative temperature | R-449A

Series / Model	Compressor		Cooling capacity / Cold room volume according to cold room temperature ⁽¹⁾						Input power (kW)	Max. current (A)	Evap. air flow (m ³ /h)	Refrigerant load (kg) ⁽²⁾	Weight (kg)	SPL dB(A) ⁽⁴⁾	Price (€)	Price with air curtain (€)
	HP	Power supply	-25 °C		-20 °C		-15 °C									
			W	m ³	W	m ³	W	m ³								
R-449A BCP-NG-0 018	5/8	230 V-I	390	1	490	2	585	3	0.67	7.2	300	< 1.0	67	31	2 297	2 797
BCP-NG-1 026	3/4	230 V-I	640	3	810	7	960	10	1.00	8.6	600	< 1.0	74	31	2 683	3 183
BCP-NG-1 034	1 1/4	230 V-I	790	4	950	10	1 120	12	1.27	11.1	600	< 1.0	80	33	2 849	3 349

Options

- ▶ Evaporator coil epoxy anti-corrosion treatment. + 6 %

Dimensions

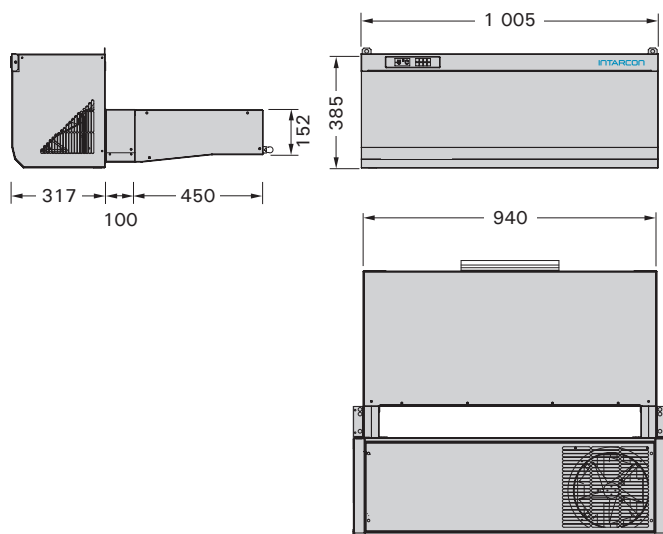

Measuring mm.

⁽¹⁾ Nominal performances refer to operation with cold room temperatures of 0 °C (PT) and -20 °C (NT) ambient temperature of 35 °C. Estimated cold room volume according to conditions of the calculation bases (page 8).

⁽²⁾ A3 refrigerant charge less than 0.5 kg, units exempt from the International Electrotechnical Committee (IEC 60335).

⁽³⁾ Units with refrigerant load less than 5 tons of CO₂ equivalent (3.5 kg of R-134a or R-449A) exempt from leak checking, Regulation (EU) No 517/2014.

⁽⁴⁾ Sound pressure in dB (A) in open field at 10 m from the unit.

Mounting frame

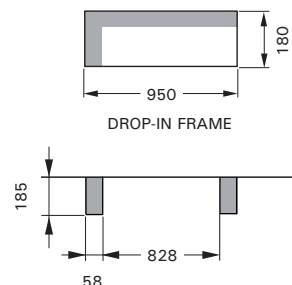



Commercial monoblock units for small-size chiller and freezer cold rooms, for ceiling panel installation.

Features

- ▶ 230 V-I-50 Hz or 400 V-III-50 Hz power supply. Available in 60 Hz. Others voltages by request.
- ▶ R-290 refrigerant load, below 0.2 kg.
- ▶ R-134a or R-449A refrigerant load, below 1.5 kg.
- ▶ Hermetic reciprocating compressor.
- ▶ High pressure switch.
- ▶ Thermostatic expansion valve.
- ▶ MCB protection.
- ▶ Hot gas defrost.
- ▶ Stainless steel drain pan.
- ▶ Evaporation of condensed water.
- ▶ Cold room LED light and micro-switch (CR-ND model).
- ▶ Cold room LED light and micro-switch cable (CR-Y/G model).
- ▶ Door heater cable (only BCR model).
- ▶ Evaporator case made in sandwich panel, with 50 mm polyurethane insulation, internally covered in steel sheet.
- ▶ Multifunction electronic control.

Series

- ▶ **CR-N:** Axial monoblock version for ceiling panel installation.
- ▶ **CR-C:** Centrifugal monoblock version with centrifugal motor fan to duct the hot condensation air outdoors.

Installation scheme

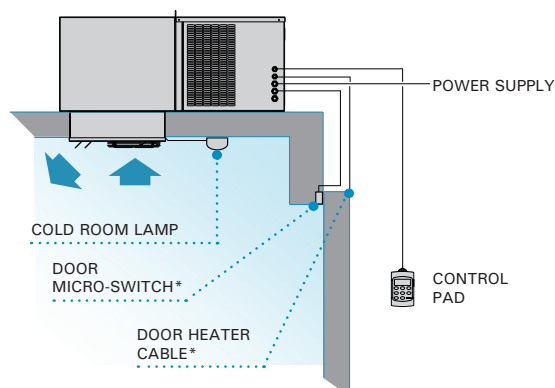

* Door heater cable only in negative temperature series.
* Door micro-switch not included (except CR-ND models).

- ❄ R-290 natural refrigerant with high energy efficiency.
- ❄ Tropicalised design for ambient temperature up to 45 °C.
- ❄ Thermostatic expansion valve.
- ❄ Hot gas defrost with temperature control.
- ❄ Units exempt from leak checks.

Installation



Electronic control

intartop units feature XWING electronic control as standard:



- Multi-function remote digital control.
- Temperature control with maximum and minimum temperature value recording.
- Quick cooling function Jet Cool.
- Night operation mode.

Centrifugal version

intartop centrifugal units feature a centrifugal motor fan to duct the hot condensation air outdoors.

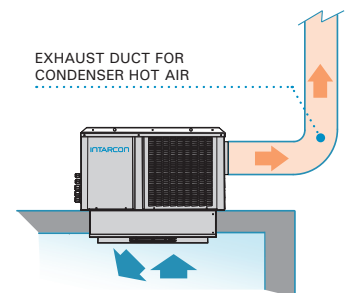

Exhaust duct

Recommended size for 20 m long steel, PVC or fibreglass ducts (each elbow at 90° equals 5 m in length). For flexible or semi-flexible ducts use a larger size:

- 0 series: 200 x 150 mm or Ø 150 mm
- 1 series: 200 x 200 mm or Ø 150 mm
- 2 series: 250 x 150 mm or Ø 200 mm
- 3 series: 200 x 300 mm or Ø 250 mm

230 V-I-50 Hz | Positive temperature | R-290

Series / Model	Compressor		Cooling capacity / Cold room volume according to cold room temperature ⁽¹⁾						Input power (kW)	Max. current (A)	Evap. air flow (m ³ /h)	Refrig. load (kg)	Weight (kg)	SPL dB(A) ⁽³⁾	Price (€)
	HP	Power supply	0 °C		5 °C		10 °C								
			W	m ³	W	m ³	W	m ³							
MCR-ND-0 009	1/3	230 V-I	670	5	780	7	900	12	0.39	3.6	300	<0.10	63	29	1 946
MCR-ND-1 012	1/2	230 V-I	1 060	9	1 240	15	1 435	27	0.53	3.4	600	<0.10	73	29	2 362
MCR-ND-1 017	3/4	230 V-I	1 370	14	1 585	21	1 815	36	0.68	4.5	600	<0.15	73	31	2 634
MCR-ND-2 026	2	230 V-I	1 850	21	2 200	34	2 577	58	0.98	5.9	1 150	<0.15	96	35	3 518
MCR-ND-2 034	2 1/2	230 V-I	2 240	27	2 650	43	2 995	70	1.35	9.0	1 150	<0.20	96	35	4 424

230 V-I-50 Hz | Negative temperature | R-290

Series / Model	Compressor		Cooling capacity / Cold room volume according to cold room temperature ⁽¹⁾						Input power (kW)	Max. current (A)	Evap. air flow (m ³ /h)	Refrig. load (kg)	Weight (kg)	SPL dB(A) ⁽³⁾	Price (€)
	HP	Power supply	-25 °C		-20 °C		-15 °C								
			W	m ³	W	m ³	W	m ³							
BCR-ND-0 014	3/4	230 V-I	385	1	460	2	550	4	0.39	3.3	300	<0.10	65	29	2 292
BCR-ND-1 017	3/4	230 V-I	540	2	660	5	800	8	0.49	3.5	600	<0.10	73	29	2 575
BCR-ND-1 028	1 1/4	230 V-I	770	4	925	9	1 100	15	0.73	6.0	600	<0.15	80	31	2 820
BCR-ND-2 034	1 1/2	230 V-I	985	7	1 215	14	1 475	25	0.99	9.3	1 150	<0.20	96	34	3 465

230 V-I-50 Hz / 400 V-III-50 Hz | Positive temperature | R-134a

Axial version Series / Model	Compressor		Cooling capacity / Cold room volume according to cold room temperature ⁽¹⁾						Input power (kW)	Max. current (A)	Evap. air flow (m ³ /h)	Refrig. load (kg) ⁽²⁾	Weight (kg)	SPL dB(A) ⁽³⁾	Price (€)	Centrifugal version			
	HP	Power supply	0 °C		5 °C		10 °C									Series / Model	Conden. air flow (m ³ /h)	ASP (mmca) ⁽⁴⁾	Price (€)
			W	m ³	W	m ³	W	m ³											
MCR-NY-0 010	3/8	230 V-I	605	4.0	751	7.0	902	12	0.43	4.5	300	<1.0	62	29	1 712	MCR-CY-0 010	375	8	1 938
MCR-NY-0 015	1/2	230 V-I	788	6.1	956	10	1 134	18	0.53	5.5	300	<1.0	65	32	1 958	MCR-CY-0 015	375	8	2 217
MCR-NY-1 015	1/2	230 V-I	999	8.2	1 231	12	1 490	23	0.58	5.6	600	<1.0	73	32	2 085	MCR-CY-1 015	575	8	2 362
MCR-NY-1 026	3/4	230 V-I	1 265	12	1 549	19	1 853	30	0.93	9.3	600	<1.0	82	30	2 542	MCR-CY-1 026	575	8	2 878
MCR-NY-1 033	1	230 V-I	1 502	16	1 817	26	2 153	41	1.05	9.5	600	<1.0	83	33	2 870	MCR-CY-1 033	575	8	3 249
MCR-NY-2 033	1	230 V-I	1 911	24	2 363	37	2 846	61	1.21	10.3	1 150	<1.5	98	34	3 263	MCR-CY-2 033	1 000	12	3 698
MCR-NY-2 053	1 1/2	230 V-I *	2 352	33	2 882	50	3 455	75	1.67	12.9	1 150	<1.5	99	38	3 866	MCR-CY-2 053	1 000	12	4 381
MCR-NY-2 074	2	230 V-I *	2 940	40	3 560	60	4 211	90	1.83	16.9	1 150	<1.5	110	44	4 280	MCR-CY-2 074	1 000	12	4 848
MCR-NY-3 108	5	400 V-III	3 725	48	4 465	71	5 155	121	2.30	15.1	1 300	<2.0	149	45	4 754	MCR-CY-3 108	1 500	14	5 199

230 V-I-50 Hz / 400 V-III-50 Hz | Negative temperature | R-449A

Axial version Series / Model	Compressor		Cooling capacity / Cold room volume according to cold room temperature ⁽¹⁾						Input power (kW)	Max. current (A)	Evap. air flow (m ³ /h)	Refrig. load (kg) ⁽²⁾	Weight (kg)	SPL dB(A) ⁽³⁾	Price (€)	Centrifugal version			
	HP	Power supply	-25 °C		-20 °C		-15 °C									Series / Model	Conden. air flow (m ³ /h)	ASP (mmca) ⁽⁴⁾	Price (€)
			W	m ³	W	m ³	W	m ³											
BCR-NG-0 018	5/8	230 V-I	418	0.6	525	1.5	638	2.8	0.59	4.7	300	<0.5	65	31	2 203	BCR-CG-0 018	375	8	2 461
BCR-NG-1 026	3/4	230 V-I	562	2.0	736	4.1	907	7.7	0.84	8.5	600	<1.0	84	31	2 568	BCR-CG-1 026	575	8	2 875
BCR-NG-1 034	1 1/4	230 V-I	703	3.2	892	5.8	1 060	10	1.05	11.0	600	<1.0	84	33	2 705	BCR-CG-1 034	575	8	3 018
BCR-NG-2 034	1 1/4	230 V-I	775	3.8	1 102	7.8	1 406	14	1.11	11.5	1 150	<1.0	135	35	3 074	BCR-CG-2 034	1 000	12	3 518
BCR-NG-2 055	1 3/4	230 V-I *	1 160	8.0	1 575	15	2 015	27	1.60	12.6	1 150	<1.5	145	41	3 616	BCR-CG-2 055	1 000	12	4 075
BCR-NG-2 075	2 1/2	230 V-I *	1 470	11	1 870	19	2 295	32	2.00	25.5	1 150	<1.5	145	44	4 083	BCR-CG-2 075	1 000	12	4 561
BCR-NG-3 075	2 1/2	230 V-I *	1 630	13	2 115	23	2 655	38	2.10	25.5	1 300	<1.5	147	44	4 546	BCR-CG-3 075	1 500	14	5 006
BCR-NG-3 096	3 1/2	400 V-III	1 850	15	2 420	27	3 010	46	2.20	11.2	1 300	<1.5	147	49	4 702	BCR-CG-3 096	1 500	14	5 147

Options

- ▶ Change to 400 V-III-50 Hz power supply (CR-Y/G models). + 5 %
- ▶ Door micro-switch (CR-Y/G models). + 53 €
- ▶ Non-return damper (centrifugal version). + 27 €
- ▶ Adaptation of air discharge to circular duct (CR-Y/G models). + 105 €
- ▶ Vertical discharge (centrifugal version).
- ▶ Evaporator coil epoxy anti-corrosion treatment. + 6 %

Dimensions

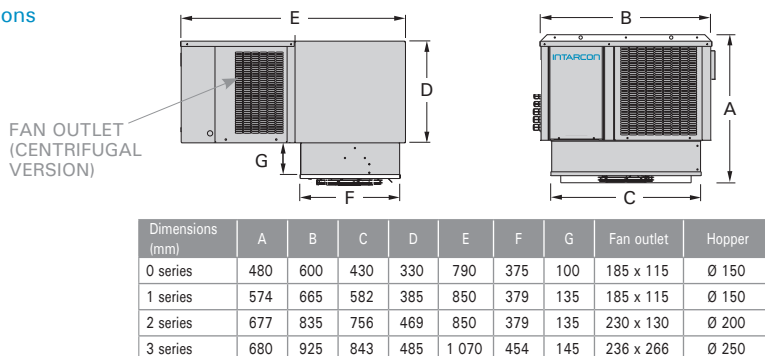

⁽¹⁾ Nominal performances refer to operation with cold room temperatures of 0 °C (PT) and -20 °C (NT) ambient temperature of 35 °C. Estimated cold room volume according to conditions of the calculation bases (page 8).

⁽²⁾ Units with refrigerant load less than 5 tons of CO₂ equivalent (3.5 kg of R-134a or R-449A) exempt from leak checking, Regulation (EU) No 517/2014.

⁽³⁾ Sound pressure in dB (A) in open field at 10 m from the unit.

⁽⁴⁾ Available static pressure of condensation.

* Units available with 400 V-III-50 Hz power supply.

Mounting frames

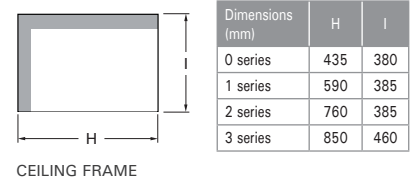

CEILING FRAME

R-290 intarblock



Self-contained slim monoblock units for wall-mount installation in small cold rooms for positive and negative temperature.

This new range of monoblock units incorporates the latest technology components in a very compact size that integrates into the wall panel of the cold room.

Features

- ▶ 230 V-I-50 Hz power supply. Available in 60 Hz. Others voltages by request.
- ▶ R-290 refrigerant load, below 0.2 kg.
- ▶ Hermetic reciprocating compressor.
- ▶ EC motor fans.
- ▶ High pressure switch.
- ▶ Thermostatic expansion valve.
- ▶ Hot gas defrost.
- ▶ Stainless steel drain pan.
- ▶ Evaporation of condensed water.
- ▶ Cold room LED light and door micro-switch cable.
- ▶ Removable through-wall insulation pad included.
- ▶ Door heater cable (only for BCV series).
- ▶ Multifunctional electronic control.

Installation scheme

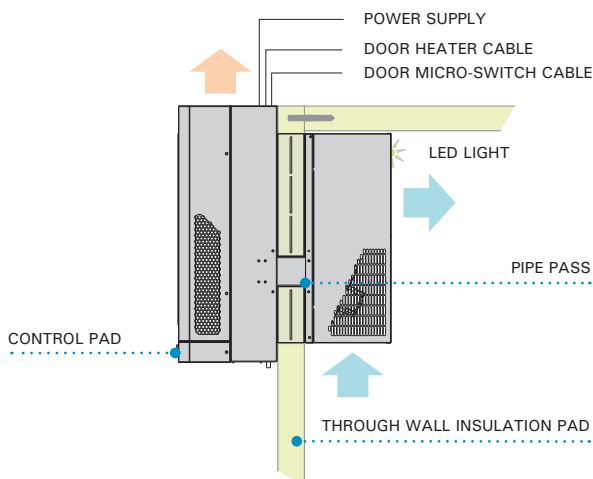

- ❄ R-290 natural refrigerant with high energy efficiency.
- ❄ Tropicalised design for ambient temperature up to 45 °C.
- ❄ Thermostatic expansion valve.
- ❄ Hot gas defrost with temperature control.

Installation



Propane

Propane or R-290 is a hydrocarbon used as a refrigerant in small commercial refrigeration units. It has a low environmental impact and excellent thermodynamic properties.

- ▶ Global-warming potential GWP = 3
- ▶ Boiling point at 1.013 bar (°C): -42.10
- ▶ Temperature slip (°C): 0
- ▶ Safety classification: A3. Not toxic but extremely flammable.
- ▶ The International Electrotechnical Committee IEC 60335 allow the use of up to 0.5 kg on compact commercial refrigeration units.

Electronic control

XW60LH electronic control, as standard on our commercial propane and door monoblock units, is an advanced small size controller, which includes the following functions:



- Temperature control with maximum and minimum temperature recording.
- Quick cooling function Jet Cool.
- Night operation mode.
- 4 output relays for: compressor, fan, defrost and light.
- 3 temperature NTC probes for cold room, defrost and condensation.

Built-in cold room LED light

High efficiency cold room LED light, built-in in the unit that is automatically activated when the cold room door is opened.

230 V-I-50 Hz | Positive temperature | R-290

Series / Model	Compressor		Cooling capacity / Cold room volume according to cold room temperature ⁽¹⁾						Input power (kW)	Max. current (A)	Evap. air flow (m ³ /h)	Refrigerant load (kg)	Weight (kg)	SPL dB(A) ⁽²⁾	Price (€)
	HP	Power supply	0 °C		5 °C		10 °C								
			W	m ³	W	m ³	W	m ³							
MCV-LD-0 009	1/3	230 V-I	635	5	740	7	850	12	0.40	3,5	300	< 0.10	38	29	1 847
MCV-LD-1 012	1/2	230 V-I	1 050	9	1 220	15	1 410	27	0.52	3,3	500	< 0.10	56	29	2 223
MCV-LD-1 017	3/4	230 V-I	1 340	14	1 560	21	1 780	36	0.68	4,3	500	< 0.15	57	31	2 479
MCV-LD-2 026	2	230 V-I	1 824	21	2 170	34	2 540	58	0.94	5,9	950	< 0.15	86	35	3 145
MCV-LD-2 034	2 1/2	230 V-I	2 215	27	2 618	43	2 960	70	1.31	9,0	950	< 0.20	86	35	3 944

230 V-I-50 Hz | Negative temperature | R-290

Series / Model	Compressor		Cooling capacity / Cold room volume according to cold room temperature ⁽¹⁾						Input power (kW)	Max. current (A)	Evap. air flow (m ³ /h)	Refrigerant load (kg)	Weight (kg)	SPL dB(A) ⁽²⁾	Price (€)
	HP	Power supply	-25 °C		-20 °C		-15 °C								
			W	m ³	W	m ³	W	m ³							
BCV-LD-0 014	3/4	230 V-I	370	1	440	2	520	4	0.38	3,6	300	< 0.10	38	29	2 193
BCV-LD-1 017	3/4	230 V-I	540	2	660	5	790	8	0.48	4,3	500	< 0.10	57	29	2 436
BCV-LD-1 028	1 1/4	230 V-I	770	4	920	9	1 090	15	0.73	5,6	500	< 0.15	64	31	2 683
BCV-LD-2 034	1 1/2	230 V-I	985	7	1 210	14	1 470	25	0.97	9,3	950	< 0.20	86	34	2 878

Options

- ▶ Evaporator coil epoxy anti-corrosion treatment.

+ 6 %

Dimensions

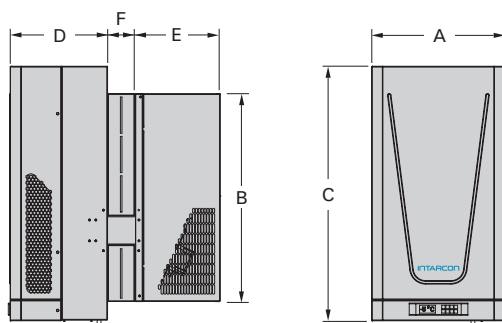

Dimensions (mm)	A	B	C	D	E	F
0 series	420	596	803	237	207	86
1 series	420	656	803	307	270	86
2 series	620	676	764	343	310	106

⁽¹⁾ Nominal performances refer to operation with cold room temperatures of 0 °C (PT) and -20 °C (NT), ambient temperature of 35 °C. Estimated cold room volume according to conditions of the calculation bases (page 8).

⁽²⁾ Units with refrigerant load less than 5 tons of CO₂ equivalent (3.5 kg of R-134a or R-449A) exempt from leak checking, Regulation (EU) No 517/2014.

⁽³⁾ Sound pressure in dB (A) in open field at 10 m from the unit.

Mounting frames



PLUG-IN FRAME

Dimensions (mm)	G	H
0 series	400	600
1 series	400	660
2 series	600	680

intarblock



Self-contained monoblock units for wall-mount installation in small cold rooms at positive and negative temperature.

Features

- ▶ 230 V-I-50 Hz or 400 V-III-50 Hz power supply. Available in 60 Hz. Others voltages by request.
- ▶ R-134a or R-449A refrigerant load, below 2 kg.
- ▶ Hermetic reciprocating compressor.
- ▶ High pressure switches.
- ▶ Thermostatic expansion valve.
- ▶ MCB protection.
- ▶ Hot gas defrost.
- ▶ Stainless steel drain pan.
- ▶ Evaporation of condensed water.
- ▶ Cold room lamp and door micro-switch cable.
- ▶ Door heater cable (only for BCV series).
- ▶ Removable through-wall insulation pad included.
- ▶ Multifunction electronic control.

Series

- ▶ **CV-N:** Monoblock units ready for quick installation through cold room wall and removable through-wall insulation pad for drop-in frame mounting.
- ▶ **CV-C:** Centrifugal version units featuring a centrifugal motor fan for ducted outlet of condenser hot air.
- ▶ **CV-I:** Weatherproof monoblock units for outdoors installations at positive and negative small cold rooms.

Installation scheme

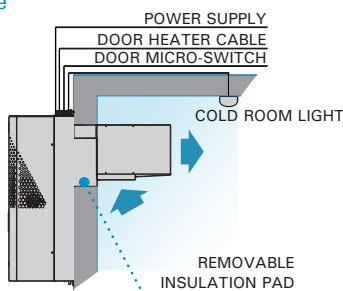

Plug-in frame mounting

A removable insulation pad is included for direct installation through a hole in the cold room wall.

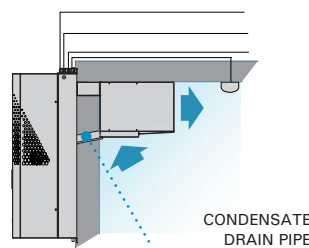

Drop-in frame mounting (except for series 0)

After cutting a channel for tube passage in the wall panel, the unit can be dropped in before assembling the ceiling panel.

- ❄ Compact unit with reduced refrigerant load, less than 2 kg.
- ❄ Tropicalised design for high ambient temperature up to 45 °C.
- ❄ Thermostatic expansion valve.
- ❄ Hot gas defrost with temperature control.
- ❄ Units exempt from leak checks.

Installation



Electronic control

intarblock units feature XWING electronic control as standard.



- Temperature control with maximum and minimum temperature value recording.
- Quick cooling function "Jet Cool".
- Night operation mode.

Centrifugal version

intarblock centrifugal units feature a centrifugal motor fan to duct hot condensation airflow outdoors.

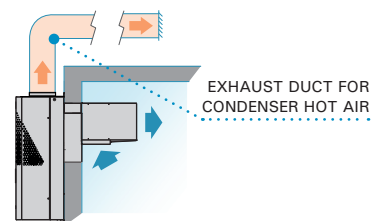

Exhaust duct

Recommended size for 20 m long steel, PVC or fibreglass ducts (each elbow at 90° equals 5 m in length). For flexible or semi-flexible ducts use a larger size.

- 0 series: 200 x 150 mm or Ø 150 mm
- 1 series: 200 x 200 mm or Ø 150 mm
- 2 series: 250 x 150 mm or Ø 200 mm
- 3 series: 300 x 200 mm or Ø 250 mm

230 V-I-50 Hz / 400 V-III-50 Hz | Positive temperature | R-134a

Axial version	Compressor		Cooling capacity / Cold room volume according to cold room temperature ⁽¹⁾						Input power (kW)	Max. current (A)	Evap. air flow (m ³ /h)	Refrig. load (kg) ⁽²⁾	Weight (kg)	SPL dB(A) ⁽³⁾	Price (€)	
			0 °C		5 °C		10 °C									
			W	m ³	W	m ³	W	m ³								
Series / Model	HP	Power supply														
R-134a	MCV-NY-0 010	3/8	230 V-I	610	4.0	758	7.0	907	12	0.43	4.5	300	<1.0	36	29	1 588
	MCV-NY-0 015	1/2	230 V-I	794	6.0	961	10	1 139	18	0.53	5.5	300	<1.0	38	32	1 834
	MCV-NY-1 015	1/2	230 V-I	972	8.0	1 199	14	1 453	23	0.57	5.6	500	<1.0	60	32	2 023
	MCV-NY-1 026	3/4	230 V-I	1 281	12	1 565	19	1 859	30	0.81	9.3	500	<1.0	69	30	2 257
	MCV-NY-1 033	1	230 V-I	1 454	14	1 743	25	2 037	41	0.92	9.5	500	<1.0	70	33	2 384
	MCV-NY-2 033	1	230 V-I	1 790	19	2 163	36	2 573	57	1.09	10.3	950	<1.5	88	34	2 937
	MCV-NY-2 053	1 1/2	230 V-I *	2 153	24	2 609	41	3 103	72	1.46	12.9	950	<1.5	89	38	3 289
	MCV-NY-3 053	1 1/2	230 V-I *	2 489	29	3 103	53	3 743	83	1.51	13.1	1 300	<2.0	117	39	3 800
	MCV-NY-3 074	2	230 V-I *	3 239	40	3 938	70	4 667	97	1.89	17.1	1 300	<2.0	114	44	4 127
	MCV-NY-3 108	5	400 V-III	3 927	51	4 725	110	5 539	130	2.48	18.6	1 300	<2.0	116	45	4 395

Centrifugal version	Conden. air flow (m ³ /h)	ASP (mmca) ⁽⁴⁾	Price (€)
MCV-CY-0 010	375	8	1 801
MCV-CY-0 015	375	8	2 077
MCV-CY-1 015	575	8	2 291
MCV-CY-1 026	575	8	2 558
MCV-CY-1 033	575	8	2 701
MCV-CY-2 033	950	13	3 327
MCV-CY-2 053	950	13	3 725
MCV-CY-3 053	1 150	8	4 461
MCV-CY-3 074	1 150	8	4 845
MCV-CY-3 108	1 150	8	5 159

230 V-I-50 Hz / 400 V-III-50 Hz | Negative temperature | R-449A

Axial version	Compressor		Cooling capacity / Cold room volume according to cold room temperature ⁽¹⁾						Input power (kW)	Max. current (A)	Evap. air flow (m ³ /h)	Refrig. load (kg) ⁽²⁾	Weight (kg)	SPL dB(A) ⁽³⁾	Price (€)	
			-25 °C		-20 °C		-15 °C									
			W	m ³	W	m ³	W	m ³								
Series / Model	HP	Power supply														
R-449A	BCV-NG-0 018	5/8	230 V-I	382	0.6	486	1.5	596	2.8	0.50	4.7	300	<0.5	38	31	2 138
	BCV-NG-1 026	3/4	230 V-I	550	2.1	721	4.3	888	7.6	0.84	8.5	550	<1.0	60	31	2 465
	BCV-NG-1 034	1 1/4	230 V-I	697	3.2	882	6.1	1 047	10	1.05	11.0	550	<1.0	60	33	2 533
	BCV-NG-2 034	1 1/4	230 V-I	793	3.8	1 049	7.7	1 341	14	1.11	11.9	950	<1.0	89	35	2 704
	BCV-NG-2 055	1 3/4	230 V-I *	1 155	8.0	1 560	15	1 960	26	1.60	17.5	950	<1.0	96	41	3 237
	BCV-NG-2 075	2 1/2	230 V-I *	1 453	11	1 835	18	2 245	31	2.00	25.5	950	<1.0	101	44	3 547
	BCV-NG-3 075	2 1/2	230 V-I *	1 680	13	2 150	23	2 635	38	2.20	26.0	1 300	<1.5	113	44	3 945
	BCV-NG-3 096	3 1/2	400 V-III	2 022	18	2 492	32	2 942	54	2.39	12.1	1 300	<1.5	129	49	4 196

Centrifugal version	Conden. air flow (m ³ /h)	ASP (mmca) ⁽⁴⁾	Price (€)
BCV-CG-0 018	375	8	2 386
BCV-CG-1 026	575	8	2 748
BCV-CG-1 034	575	8	2 811
BCV-CG-2 034	950	13	3 116
BCV-CG-2 055	950	13	3 657
BCV-CG-2 075	950	13	3 969
BCV-CG-3 075	1 150	8	4 570
BCV-CG-3 096	1 150	8	4 835

Options

- ▶ Change to 400 V-III-50 Hz power supply. + 5 %
- ▶ Door micro-switch. + 53 €
- ▶ Non-return damper (centrifugal version). + 27 €
- ▶ Adaptation of air discharge to circular duct. + 105 €
- ▶ Evaporator coil epoxy anti-corrosion treatment. + 6 %

Dimensions

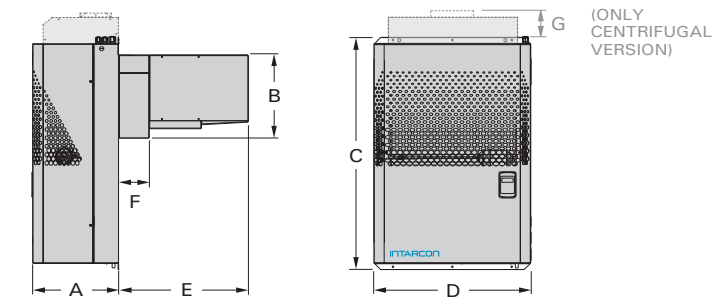

Dimensions (mm)	A	B	C	D	E	F	G	Fan outlet
0 series	306	510	683	420	250	100	90	185 x 115
1 series	340	330	880	400	514	122	42	185 x 115
2 series	340	330	920	620	514	122	140	230 x 130
3 series	365	470	940	735	514	122	50	2x 185 x 115

⁽¹⁾ Nominal performances refer to operation with cold room temperatures of 0 °C (PT) and -20 °C (NT) ambient temperature of 35 °C. Estimated cold room volume according to conditions of the calculation bases (page 8).

⁽²⁾ Units with refrigerant load less than 5 tons of CO₂ equivalent (3.5 kg of R-134a or R-449A) exempt from leak checking, Regulation (EU) No 517/2014.

⁽³⁾ Sound pressure in dB (A) in open field at 10 m from the unit.

⁽⁴⁾ Available Static Pressure of condensation.

* Available units with 400 V-III-50 Hz power supply.

Mounting frame

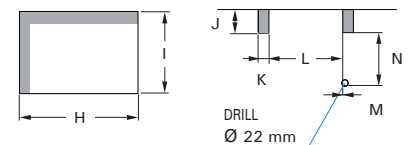

PLUG-IN FRAME

DROP-IN FRAME

Dimensions (mm)	H	I	J	K	L	M	N
0 series	405	515			n/a		
1 series	380	335	75	41	295	13	233
2 series	600	335	75	36	523	13	233
3 series	710	475	75	41	611	22	356

230 V-I-50 Hz / 400 V-III-50 Hz | **Positive temperature** | **R-452A**

Series / Model	Compressor		Cooling capacity / Cold room volume according to cold room temperature ⁽¹⁾								Input power (kW)	Max. current (A)	Evap. air flow (m³/h)	Conden. air flow (m³/h)	Refrig. load (kg)	Weight (kg)	SPL dB(A) ⁽²⁾	Price (€)
	HP	Power supply	-5 °C		0 °C		5 °C		10 °C									
			W	m³	W	m³	W	m³	W	m³								
MCV-IB-1 010	3/8	230 V-I	630	3.5	799	6.4	966	11	1 157	19	0.65	5.5	500	575	< 1.0	59	34	2 493
MCV-IB-1 012	1/2	230 V-I	767	4.9	930	8.2	1 118	14	1 317	23	0.67	6.5	500	575	< 1.0	60	34	2 572
MCV-IB-1 014	1/2	230 V-I	893	6.3	1 077	10	1 270	16	1 485	27	0.80	7.1	500	575	< 1.0	60	34	2 654
MCV-IB-1 016	5/8	230 V-I	985	7.4	1 184	12	1 386	19	1 615	30	0.87	8.0	500	575	< 1.0	69	34	2 734
MCV-IB-1 018	3/4	230 V-I	1 138	9.3	1 347	14	1 570	22	1 806	35	1.02	9.3	500	575	< 1.0	70	34	2 870
MCV-IB-1 024	1	230 V-I	1 207	10	1 468	16	1 739	25	2 039	41	1.18	12.3	500	575	< 1.0	70	34	3 032
MCV-IB-2 024	1	230 V-I	1 554	14	1 917	23	2 296	36	2 726	57	1.36	11.9	950	950	< 1.0	88	35	3 734
MCV-IB-2 026	1 1/4	230 V-I *	1 795	17	2 149	26	2 526	40	2 945	63	1.47	12.3	950	950	< 1.0	89	36	3 953
MCV-IB-2 034	1 1/2	230 V-I *	1 996	20	2 391	31	2 801	46	3 247	72	1.95	16.9	950	950	< 1.5	89	37	4 169
MCV-IB-3 034	1 1/2	230 V-I *	2 230	23	2 690	35	3 200	53	3 730	83	2.07	17.1	1 300	1 250	< 2.0	117	38	4 565
MCV-IB-3 038	1 3/4	400 V-III	2 500	27	3 020	41	3 580	62	4 220	97	1.97	7.9	1 300	1 250	< 1.5	114	40	4 960

230 V-I-50 Hz / 400 V-III-50 Hz | **Negative temperature** | **R-452A**

Series / Model	Compressor		Cooling capacity / Cold room volume according to cold room temperature ⁽¹⁾						Input power (kW)	Max. current (A)	Evap. air flow (m³/h)	Conden. air flow (m³/h)	Refrig. load (kg)	Weight (kg)	SPL dB(A) ⁽²⁾	Price (€)	
	HP	Power supply	-25 °C		-20 °C		-15 °C										
			W	m³	W	m³	W	m³									
BCV-IB-1 018	5/8	230 V-I	383	1.0	489	2.0	655	4.4	0.67	7.3	500	575	< 0.5	59	31	3 170	
BCV-IB-1 026	3/4	230 V-I	548	2.1	720	4.3	877	7.6	0.91	8.5	500	575	< 1.0	60	31	3 235	
BCV-IB-1 034	1 1/4	230 V-I	668	3.2	866	6.1	1 023	10	1.14	11.0	500	575	< 1.0	60	33	3 322	
BCV-IB-2 034	1 1/4	230 V-I	793	3.8	1 048	7.7	1 297	14	1.19	11.9	950	950	< 1.0	89	35	3 547	
BCV-IB-2 055	1 3/4	230 V-I *	1 280	11	1 650	14	2 025	22	1.80	17.9	950	950	< 1.0	96	41	4 247	
BCV-IB-2 075	2 1/2	230 V-I *	1 580	15	1 900	17	2 355	27	2.30	25.9	950	950	< 1.0	101	44	4 654	
BCV-IB-3 075	2 1/2	230 V-I *	1 630	16	2 130	19	2 540	30	2.50	26.0	1 300	1 250	< 1.5	113	44	5 203	
BCV-IB-3 096	3 1/2	400 V-III	1 890	18	2 460	32	3 040	54	2.64	12.1	1 300	1 250	< 1.5	129	49	5 508	

Options

- ▶ Change to 400 V-III-50 Hz power supply. + 5 %
- ▶ Door micro-switch. + 53 €
- ▶ Condenser coil polyurethane anti-corrosion treatment. + 4 %
- ▶ Evaporator coil epoxy anti-corrosion treatment. + 6 %
- ▶ Male and female schuko electrical connector base. + 63 €
- ▶ Low voltage protection (single-phase models). + 157 €
- ▶ Low voltage and phase sequence protection (three-phase models). + 209 €

Dimensions

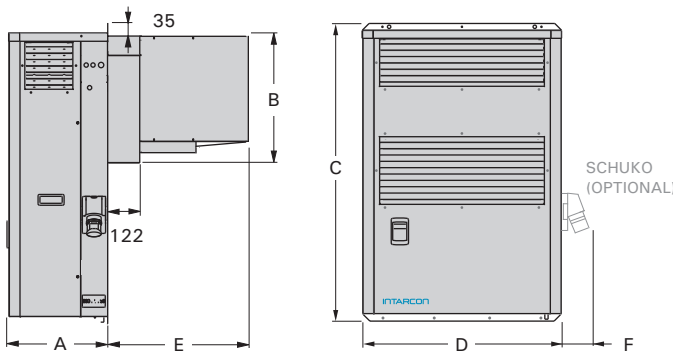

Measuring mm.

Dimensions (mm)	A	B	C	D	E	F
1 series	340	330	1 060	400	514	115
2 series	340	330	1 100	620	514	115
3 series	365	470	1 100	735	514	115
3 096 series	365	470	1 215	735	514	115

⁽¹⁾ Nominal performances refer to operation with cold room temperatures of 0 °C (PT) and -20 °C (NT) ambient temperature of 35 °C. Estimated cold room volume according to conditions of the calculation bases (page 8).

⁽²⁾ Sound pressure in dB (A) in open field at 10 m from the unit.

* Available units with 400 V-III-50 Hz power supply.

Mounting frame

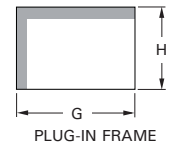

Dimensions (mm)	G	H
1 series	380	335
2 series	600	335
3 series	710	475

Installations scheme





Split systems

Condensing and evaporator unit



Low-noise
construction



Units exempt
from leak checks



Refrigerant
pre-load

intarsplit



Split systems for small and medium size cold rooms at positive and negative temperature, composed by a condensing unit in horizontal construction and a slim-type, cubic-type or double-flow evaporating unit.

Features

- ▶ 230 V-I-50 Hz or 400 V-III-50 Hz power supply. Available in 60 Hz. Others voltages by request.
- ▶ Minimal R-134a or R-449A refrigerant load.
- ▶ Hermetic reciprocating compressor (noise insulation in 3-phases models).
- ▶ High and low pressure switches.
- ▶ Liquid receiver.
- ▶ Refrigerant pre-load for 10 m of piping.
- ▶ Thermostatic expansion valve.
- ▶ Electrical heater defrost (except ASH series).
- ▶ Stainless steel drain pan.
- ▶ Flare-type connections (up to 3/8"-3/4") and service valves.
- ▶ 10 m of electrical connections included (except for 4 and 40 up to 54 series).
- ▶ MCB protection.
- ▶ Multifunction electronic control with remote keyboard and digital regulation of condensing pressure.
- ▶ Liquid injection system for negative temperature models with R-449A.

Series

- ▶ **SH-N:** Split systems with axial condensing unit and slim-type evaporating unit.
- ▶ **SH-Q:** Split systems with axial condensing unit and cubic-type evaporating unit.
- ▶ **SH-C:** Split systems with centrifugal condensing unit and slim-type evaporating unit.
- ▶ **SH-CQ:** Split systems with centrifugal condensing unit and cubic-type evaporating unit.
- ▶ **SH-D:** Split systems with axial condensing unit and double-flow evaporating unit.
- ▶ **SH-CD:** Split systems with centrifugal condensing unit and double-flow evaporating unit.

Installation scheme

Maximum vertical distance between units of 15 m if the condensing unit is placed at a higher level than the evaporating unit, and 6 m otherwise.

*20 % minimum slope of draining pipe for negative temperature models.

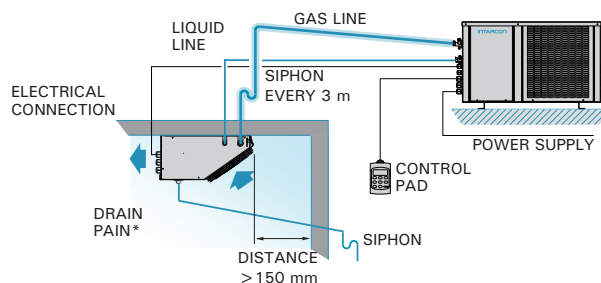

- ❄ Units exempt from leak checks.
- ❄ Factory-tested systems with no need for on-site tests.
- ❄ Tropicalised design for high ambient temperature up to 45 °C.
- ❄ Built-in thermostatic expansion valve.
- ❄ Refrigerant pre-load.

Control pad

intarsplit systems feature XM670K electronic control as standard.



- Remote control keyboard with digital display.
- Temperature control with maximum and minimum temperature value recording.
- Possibility of interconnection and synchronization of up to 8 devices by LAN, managed from a single control.

Digital condensing control

Standard as intarsplit series, it protects the unit against occasional low ambient temperatures. For prolonged operations with negative temperature outside it is recommended to install the proportional condensation control (optional in series 3 and 33 onwards).

Crankcase Heater (optional)

The inclusion of the optional crankcase heater is recommended in all outdoor units.

Centrifugal version

The units of the centrifugal intarsplit series incorporates a centrifugal turbine that allows the condensation hot air to be transported outside by means of air ducts.

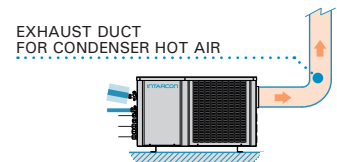

Electrical interconnections (SH-N/-C models)

For the interconnection of the condenser and evaporator units, the following cable sections must be provided for a length of 10 m.

Power supply	230 V-I-50 Hz	400 V-III-50 Hz
Probes	4 x 1 mm ²	
Manoeuvre	2 x 1 mm ²	3 x 1 mm ²
Defrost	2 x 1.5 mm ² + G	4 x 1.5 mm ² + G
Control pad	2 x 1 mm ²	
Switch door*	2 x 1 mm ²	
Door heater cable	2 x 1 mm ² at NT	
Cold room light*	2 x 1 mm ² + G	

* Optional not included.
To know electrical interconnections of each model: see technical manual.

230 V-I-50 Hz / 400 V-III-50 Hz | Positive temperature | R-134a / R-449A

Axial version	Compressor		Cooling capacity / Cold room volume according to cold room temperature ⁽¹⁾						Input power (kW)	Max. current (A)	Evap. air flow (m ³ /h)	Liq-Gas cooling connection	Refrig. load (kg) ⁽²⁾	Weight (kg)	SPL dB(A) ⁽³⁾	Price (€)	
			0 °C		5 °C		10 °C										
	Series / Model	HP	Power supply	W	m ³	W	m ³	W									m ³
R-134a	MSH-NY-00 010	3/8	230 V-I	643	5.1	788	8.5	945	13	0.46	4.6	300	1/4"-3/8"	<1.5	37+12	29	2 182
	MSH-NY-00 015	1/2	230 V-I	832	7.2	1 010	10	1 193	19	0.56	5.6	300	1/4"-3/8"	<1.5	40+12	32	2 364
	MSH-NY-11 015	1/2	230 V-I	988	8.2	1 220	12	1 474	23	0.58	5.6	550	1/4"-1/2"	<1.5	41+16	32	2 499
	MSH-NY-11 026	3/4	230 V-I	1 250	12	1 533	18	1 827	30	0.82	9.3	550	1/4"-1/2"	<1.5	48+16	30	3 227
	MSH-NY-11 033	1	230 V-I	1 481	16	1 790	24	2 116	41	0.93	9.5	550	1/4"-1/2"	<1.5	50+16	33	3 473
	MSH-NY-22 033	1	230 V-I	1 922	23	2 368	36	2 846	60	1.06	10.0	1 050	1/4"-5/8"	<2.0	53+24	34	3 874
	MSH-NY-22 053	1 1/2	230 V-I *	2 363	31	2 882	48	3 455	73	1.45	12.6	1 050	1/4"-5/8"	<2.0	63+24	38	4 294
	MSH-NY-33 053	1 1/2	230 V-I *	2 688	40	3 318	63	4 069	100	1.55	13.2	1 725	1/4"-3/4"	<3.5	82+45	38	4 489
	MSH-NY-33 074	2	230 V-I *	3 518	47	4 347	71	5 198	110	1.93	17.2	1 725	1/4"-3/4"	<3.5	84+45	44	4 837
	MSH-NY-43 086	4	400 V-III	4 379	66	5 366	100	6 421	165	2.39	14.9	1 725	3/8"-7/8"	<5.0	107+55	48	5 750
R-449A	MSH-NY-44 108	5	400 V-III	5 628	88	6 888	140	8 274	220	3.05	19.2	3 100	3/8"-7/8"	<5.0	109+55	45	6 380
	MSH-NY-44 136	6 1/2	400 V-III	6 862	115	8 311	170	9 881	260	3.77	23.2	3 100	3/8"-1 1/8"	<5.5	112+55	44	7 978
	MSH-NG-0 008	1/3	230 V-I	758	5.1	900	8.5	1 071	13	0.47	5.1	300	1/4"-3/8"	<1.5	38+12	34	2 057
	MSH-NG-0 010	3/8	230 V-I	893	6.1	1 042	10	1 223	15	0.58	4.8	300	1/4"-3/8"	<1.5	40+12	34	2 227
	MSH-NG-0 012	1/2	230 V-I	980	7.2	1 135	12	1 324	19	0.65	5.6	300	1/4"-3/8"	<1.5	41+12	34	2 355
	MSH-NG-1 014	1/2	230 V-I	1 100	10	1 313	16	1 564	26	0.79	6.7	550	1/4"-1/2"	<1.5	44+16	34	2 641
	MSH-NG-1 016	5/8	230 V-I	1 216	12	1 451	18	1 734	30	0.85	7.6	550	1/4"-1/2"	<1.5	53+16	34	2 814
	MSH-NG-1 018	3/4	230 V-I	1 404	14	1 653	22	1 954	35	1.00	8.9	550	1/4"-1/2"	<1.5	54+16	34	3 044
	MSH-NG-1 024	1	230 V-I	1 528	16	1 811	24	2 140	41	1.01	11.1	550	1/4"-1/2"	<1.5	54+16	34	3 273
	MSH-NG-2 024	1	230 V-I	2 020	23	2 424	36	2 896	60	1.27	11.6	1 050	1/4"-1/2"	<1.5	65+24	35	3 651
MSH-NG-2 026	1 1/4	230 V-I *	2 230	26	2 640	41	3 131	64	1.36	12.0	1 050	1/4"-1/2"	<1.5	66+24	36	3 823	
MSH-NG-2 034	1 1/2	230 V-I *	2 543	31	2 985	48	3 516	73	1.80	16.6	1 050	1/4"-5/8"	<1.5	66+24	37	3 996	
MSH-NG-3 034	1 1/2	230 V-I *	3 091	40	3 674	63	4 364	100	1.67	17.0	1 725	1/4"-5/8"	<3.5	74+45	38	4 190	
MSH-NG-3 038	1 3/4	400 V-III	3 459	47	4 060	71	4 786	110	1.53	7.8	1 725	1/4"-5/8"	<4.0	71+45	40	4 560	
MSH-NG-4 048	2	400 V-III	4 494	66	5 350	98	6 358	155	2.61	10.5	1 725	3/8"-3/4"	<5.5	95+45	36	5 290	
MSH-NG-4 054	2 1/2	400 V-III	4 949	74	5 847	110	6 916	170	2.80	11.0	1 725	3/8"-3/4"	<5.0	96+45	36	5 655	

Centrifugal version	Conden. air flow (m ³ /h)	ASP (mmca) ⁽⁴⁾	Price (€)
Series / Model			
MSH-CY-00 010	375	8	2 422
MSH-CY-00 015	375	8	2 624
MSH-CY-11 015	575	8	2 771
MSH-CY-11 026	575	8	3 584
MSH-CY-11 033	575	8	3 856
MSH-CY-22 033	1 000	12	4 299
MSH-CY-22 053	1 000	12	4 768
MSH-CY-33 053	1 500	14	4 983
MSH-CY-33 074	1 500	14	5 370
MSH-CY-43 086	3 500	10	6 380
MSH-CY-44 108	3 500	10	7 085
MSH-CY-44 136	3 500	10	8 857
MSH-CG-0 008	375	8	2 261
MSH-CG-0 010	375	8	2 450
MSH-CG-0 012	375	8	2 590
MSH-CG-1 014	575	8	2 924
MSH-CG-1 016	575	8	3 108
MSH-CG-1 018	575	8	3 352
MSH-CG-1 024	575	8	3 632
MSH-CG-2 024	1 000	12	4 035
MSH-CG-2 026	1 000	12	4 256
MSH-CG-2 034	1 000	12	4 440
MSH-CG-3 034	1 500	14	4 649
MSH-CG-3 038	1 500	14	5 053
MSH-CG-4 048	3 500	10	5 855
MSH-CG-4 054	3 500	10	6 233

230 V-I-50 Hz / 400 V-III-50 Hz | Negative temperature | R-449A

Axial version	Compressor		Cooling capacity / Cold room volume according to cold room temperature ⁽¹⁾						Input power (kW)	Max. current (A)	Evap. air flow (m ³ /h)	Liq-Gas cooling connection	Refrig. load (kg) ⁽²⁾	Weight (kg)	SPL dB(A) ⁽³⁾	Price (€)	
			-25 °C		-20 °C		-15 °C										
	Series / Model	HP	Power supply	W	m ³	W	m ³	W									m ³
R-449A	BSH-NG-0 018	5/8	230 V-I	422	0.9	537	1.8	658	3.9	0.60	4.8	300	1/4"-1/2"	<1.5	41+12	31	2 593
	BSH-NG-1 026	3/4	230 V-I	559	2.1	711	4.2	900	7.3	0.84	8.7	550	1/4"-1/2"	<2.5	55+16	31	2 765
	BSH-NG-1 034	1 1/4	230 V-I	622	3.0	858	5.9	1 038	10	1.05	11.2	550	1/4"-1/2"	<2.5	56+16	33	3 079
	BSH-NG-2 034	1 1/4	230 V-I	815	4.0	1 056	8.0	1 377	14	1.18	11.5	1 050	1/4"-1/2"	<2.5	66+24	35	3 383
	BSH-NG-2 055	1 3/4	230 V-I *	1 175	8.0	1 675	16	2 090	28	1.70	17.5	1 050	1/4"-5/8"	<2.5	66+24	41	4 038
	BSH-NG-2 075	2 1/2	230 V-I *	1 620	13	2 035	21	2 435	34	2.10	25.5	1 050	1/4"-5/8"	<3.5	66+24	44	4 677
	BSH-NG-3 075	2 1/2	230 V-I *	1 795	15	2 410	26	3 020	46	2.30	26.3	1 725	1/4"-5/8"	<3.5	85+45	44	4 891
	BSH-NG-3 096	3 1/2	400 V-III	2 046	23	2 745	37	3 435	62	2.18	12.4	1 725	1/4"-3/4"	<3.5	85+45	49	5 116
	BSH-NG-4 108	4 1/4	400 V-III	2 851	34	3 588	55	4 378	94	3.18	15.5	1 725	3/8"-7/8"	<5.5	107+45	47	6 778
	BSH-NG-4 136	5	400 V-III	3 289	42	4 064	67	4 895	110	4.37	17.4	1 725	3/8"-7/8"	<5.0	107+45	42	7 574

Centrifugal version	Conden. air flow (m ³ /h)	ASP (mmca) ⁽⁴⁾	Price (€)
Series / Model			
BSH-CG-0 018	375	8	2 799
BSH-CG-1 026	575	8	2 971
BSH-CG-1 034	575	8	3 304
BSH-CG-2 034	1 000	12	3 616
BSH-CG-2 055	1 000	12	4 330
BSH-CG-2 075	1 000	12	4 995
BSH-CG-3 075	1 500	14	5 265
BSH-CG-3 096	1 500	14	5 772
BSH-CG-4 108	3 500	10	7 409
BSH-CG-4 136	3 500	10	8 247

Options

- ▶ Change to 400 V-III-50 Hz power supply. + 5 %
- ▶ Crankcase heater. + 63 €
- ▶ Proportional control of condensing pressure:
Axial version (N): 3/33 and 4/43/44 series. + 262 €
Centrifugal version (C): 4/43/44 series. + 418 €
- ▶ Vertical air flow (centrifugal version).
- ▶ Rectangular to circular exhaust air adaptor. + 105 €
- ▶ Built-in oil separator. + 617 €
- ▶ Anti-corrosion evaporator coil coating. + 6 %
- ▶ Anti-corrosion condenser coil coating. + 4 %
- ▶ Larger sized multifunction electronic control. + 157 €

⁽¹⁾ Nominal performances refer to operation with cold room temperatures of 0 °C (PT) and -20 °C (NT) ambient temperature of 35 °C. Estimated cold room volume according to conditions of the calculation bases (page 8).

⁽²⁾ Units with refrigerant load less than 5 tons of CO₂ equivalent (3.5 kg of R-134a or R-449A) exempt from leak checking, Regulation (EU) No 517/2014.

⁽³⁾ Sound pressure in dB (A) in open field at 10 m from the unit.

⁽⁴⁾ Available static pressure of condensation

* Available units with 400 V-III-50 Hz power supply.

Dimensions

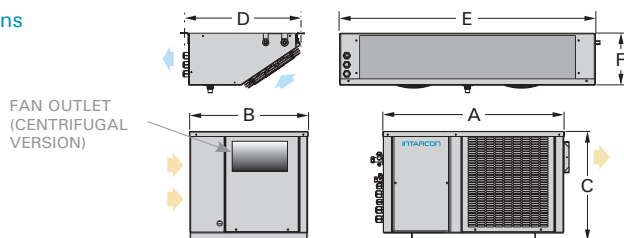

Dimensions (mm)	A	B	C	D	E	F	Evaporator fan	Fan outlet
0 and 00 series	600	395	355	417	563	150	1x Ø 172	185 x 115
1 and 11 series	665	435	416	430	643	200	1x Ø 200	185 x 115
2 and 22 series	835	435	500	430	993	200	2x Ø 200	230 x 130
3 and 33 series	925	580	515	508	1 691	200	3x Ø 254	236 x 266
4 and 43 series	1 000	615	585	508	1 691	200	3x Ø 254	305 x 266
44 series	1 000	615	585	547	2 064	250	4x Ø 300	305 x 266

230 V-I-50 Hz / 400 V-III-50 Hz | **Positive temperature** | R-134a / R-449A

Axial version	Compressor		Cooling capacity / Cold room volume according to cold room temperature ⁽¹⁾						Input power (kW)	Max. current (A)	Evap. air flow (m ³ /h)	Liq-Gas Cooling Connection	Refrig. load (kg) ⁽²⁾	Weight (kg)	SPL dB(A) ⁽³⁾	Price (€)	
	Series / Model	HP	Power supply	0 °C		5 °C		10 °C									
				W	m ³	W	m ³	W									m ³
R-134a	MSH-QY-30 068	3 1/2	400 V-III	3 854	54	4 646	59	5 513	84	2.00	12.0	2 100	1/4"-3/4"	< 4.0	74+43	37	5 373
	MSH-QY-40 086	4	400 V-III	4 431	63	5 418	68	6 500	100	2.35	14.3	2 100	3/8"-7/8"	< 5.0	107+43	48	6 281
	MSH-QY-41 108	5	400 V-III	5 324	71	6 500	80	7 775	110	2.77	17.3	2 700	3/8"-7/8"	< 5.0	109+56	45	6 976
	MSH-QY-42 136	6 1/2	400 V-III	7 235	110	8 773	180	10 474	280	3.85	22.0	4 150	3/8"-1 1/8"	< 5.0	112+72	44	8 719
	MSH-QY-53 171	8	400 V-III	7 830	135	9 535	185	11 520	300	4.25	24.1	5 200	3/8"-1 1/8"	< 5.5	162+89	50	10 111
	MSH-QY-53 215	10	400 V-III	9 450	175	11 435	230	13 740	350	5.01	30.5	6 200	3/8"-1 1/8"	< 5.5	166+94	49	11 121
	MSH-QY-54 271	13	400 V-III	12 400	240	14 760	320	17 420	400	7.13	40.2	8 300	1/2"-1 3/8"	< 5.5	171+118	48	13 018
R-449A	MSH-QG-30 034	1 1/2	230 V-I *	3 409	39	4 054	62	4 797	99	1.61	16.3	2 100	1/4"-5/8"	< 3.5	74+43	38	4 611
	MSH-QG-30 038	1 3/4	400 V-III	3 647	46	4 301	70	5 063	110	1.79	7.1	2 100	1/4"-5/8"	< 3.5	71+43	40	4 849
	MSH-QG-40 048	2	400 V-III	4 752	67	5 559	99	6 554	159	2.42	9.8	2 100	3/8"-3/4"	< 4.5	95+43	36	5 671
	MSH-QG-40 054	2 1/2	400 V-III	5 203	76	6 060	113	7 106	178	2.61	10.3	2 100	3/8"-3/4"	< 5.0	96+43	36	6 047
	MSH-QG-41 060	3	400 V-III	6 049	86	7 038	128	8 260	198	3.07	11.3	2 700	1/2"-3/4"	< 5.0	97+56	36	6 553
	MSH-QG-41 068	3 1/2	400 V-III	6 545	113	7 581	163	8 866	253	3.44	12.3	2 700	1/2"-3/4"	< 5.0	98+56	35	7 874
	MSH-QG-52 086	4	400 V-III	8 056	125	9 542	185	11 320	315	3.87	15.0	4 150	1/2"-7/8"	< 5.0	135+72	48	9 376
	MSH-QG-52 108	5	400 V-III	9 386	160	11 011	220	12 991	375	4.90	18.0	4 150	1/2"-7/8"	< 7.0	157+72	45	9 772
	MSH-QG-53 136	6 1/2	400 V-III	11 894	190	13 856	260	16 173	430	6.67	21.0	6 200	1/2"-1 1/8"	< 9.0	140+94	44	10 573

Centrifugal version	Condens. air flow (m ³ /h)	ASP (mmca) ⁽⁴⁾	Price (€)
MSH-CQY-30 068	1 500	14	5 961
MSH-CQY-40 086	3 500	10	6 969
MSH-CQY-41 108	3 500	10	7 743
MSH-CQY-42 136	3 500	10	9 679
MSH-CQY-53 171	3 600	10	11 145
MSH-CQY-53 215	3 600	10	12 225
MSH-CQY-54 271	3 600	10	14 384
MSH-CQG-30 034	1 500	14	5 052
MSH-CQG-30 038	1 500	14	5 305
MSH-CQG-40 048	3 500	10	6 135
MSH-CQG-40 054	3 500	10	6 517
MSH-CQG-41 060	3 500	10	7 030
MSH-CQG-41 068	3 500	10	8 371
MSH-CQG-52 086	3 600	12	9 880
MSH-CQG-52 108	3 600	12	10 277
MSH-CQG-53 136	3 600	12	11 076

230 V-I-50 Hz / 400 V-III-50 Hz | **Negative temperature** | R-449A

Axial version	Compressor		Cooling capacity / Cold room volume according to cold room temperature ⁽¹⁾						Input power (kW)	Max. current (A)	Evap. air flow (m ³ /h)	Liq-Gas Cooling Connection	Refrig. load (kg) ⁽²⁾	Weight (kg)	SPL dB(A) ⁽³⁾	Price (€)	
	Series / Model	HP	Power supply	-25 °C		-20 °C		-15 °C									
				W	m ³	W	m ³	W									m ³
R-449A	BSH-QG-30 075	2 1/2	230 V-I *	1 765	14	2 425	27	3 050	47	2.30	25.1	2 100	1/4"-5/8"	< 3.5	85+43	44	5 132
	BSH-QG-30 096	3 1/2	400 V-III	2 354	22	2 925	36	3 533	61	2.34	11.2	2 100	1/4"-3/4"	< 3.5	85+43	49	5 706
	BSH-QG-41 108	4 1/4	400 V-III	2 988	34	3 799	58	4 656	99	2.94	14.4	2 700	3/8"-7/8"	< 5.0	107+56	47	7 436
	BSH-QG-42 136	5	400 V-III	4 205	51	5 119	85	6 092	144	4.16	17.3	4 150	3/8"-7/8"	< 5.0	107+72	42	8 875
	BSH-QG-53 215	7 1/2	400 V-III	5 692	80	7 300	120	8 976	200	6.08	25.0	5 200	1/2"-1 1/8"	< 7.0	166+89	49	11 613
	BSH-QG-53 271	10	400 V-III	7 329	110	9 048	150	10 877	220	7.71	30.0	6 200	1/2"-1 1/8"	< 7.5	166+94	49	12 235

Centrifugal version	Condens. air flow (m ³ /h)	ASP (mmca) ⁽⁴⁾	Price (€)
BSH-CQG-30 075	1 500	14	5 420
BSH-CQG-30 096	1 500	14	6 231
BSH-CQG-41 108	3 500	10	7 949
BSH-CQG-42 136	3 500	10	9 410
BSH-CQG-53 215	3 600	12	12 149
BSH-CQG-53 271	3 600	12	12 769

Options

- ▶ Change to 400 V-III-50 Hz power supply. + 5 %
- ▶ Crankcase heater. + 63 €
- ▶ Proportional control of condensing pressure:
 - Axial version (Q). + 262 €
 - Centrifugal version (CQ): 40/41/42/52/53/54 series. + 418 €
- ▶ Vertical air flow (centrifugal version).
- ▶ Rectangular to circular exhaust air adaptor. + 105 €
- ▶ Built-in oil separator. + 617 €
- ▶ Anti-corrosion evaporator coil coating. + 6 %
- ▶ Anti-corrosion condenser coil coating. + 4 %
- ▶ Larger sized multifunction electronic control. + 157 €

Dimensions

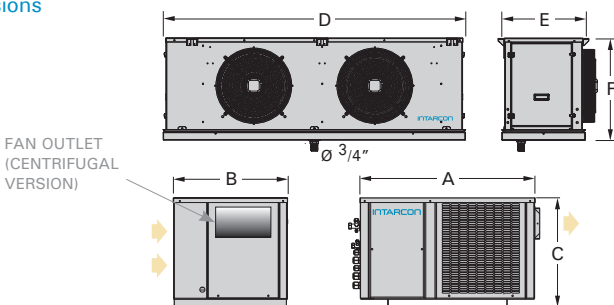

Dimensions (mm)	A	B	C	D	E	F	Evaporator fan	Fan outlet
30 series	925	580	515	881	455	553	1x Ø 350	236 x 266
40 series	1 000	615	585	881	455	553	1x Ø 350	305 x 266
41 series	1 000	615	585	1 231	455	553	1x Ø 350	305 x 266
42 series	1 000	615	585	1 531	455	553	2x Ø 350	305 x 266
52 series	1 290	755	656	1 531	455	553	2x Ø 350	305 x 266
MSH-QY-53 171 BSH-QG-53 215	1 290	755	656	1 932	455	553	2x Ø 350	305 x 266
53 series	1 290	755	656	1 932	455	553	3x Ø 350	305 x 266
54 series	1 290	755	656	2 432	455	553	4x Ø 350	305 x 266

⁽¹⁾ Nominal performances refer to operation with cold room temperatures of 0 °C (PT) and -20 °C (NT) ambient temperature of 35 °C. Estimated cold room volume according to conditions of the calculation bases (page 8).

⁽²⁾ Units with refrigerant load less than 5 tons of CO₂ equivalent (3.5 kg of R-134a or R-449A) exempt from leak checking, Regulation (EU) No 517/2014.

⁽³⁾ Sound pressure in dB (A) in open field at 10 m from the unit.

⁽⁴⁾ Available static pressure of condensation.

* Available units with 400 V-III-50 Hz power supply.

Installation scheme

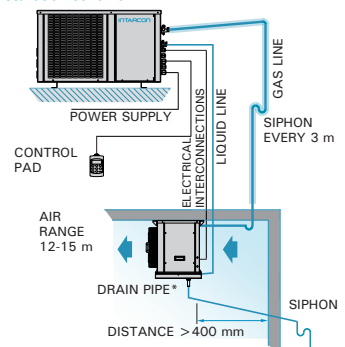

* Minimum slope of the drain pipe of 20 % in negative temperature models.

Electrical interconnections

For the interconnection of the condenser and evaporator units, the following cable sections must be provided for a length of 10 m.

Power supply	230 V-I-50 Hz	400 V-III-50 Hz
Probes	4 x 1 mm ²	
Manoeuvre	2 x 1 mm ²	3 x 1 mm ²
Defrost	2 x 1.5 mm ² + G	4 x 1.5 mm ² + G
Control pad	2 x 1 mm ²	
Switch door*	2 x 1 mm ²	
Door heater cable	2 x 1 mm ² at NT	
Cold room light*	2 x 1 mm ² + G	

* Optional not included. To know electrical interconnections of each model: see technical manual.

230 V-I-50 Hz / 400 V-III-50 Hz | High temperature | R-134a / R-449A

Axial version	Compressor		Cooling capacity / Cold room volume according to cold room temperature ⁽¹⁾						Input power (kW)	Max. current (A)	Evap. air flow (m ³ /h)	Liq-Gas cooling connection	Refrig. load (kg) ⁽²⁾	Weight (kg)	SPL dB(A) ⁽³⁾	Price (€)	Centrifugal version	Condens. air flow (mmca) ⁽⁴⁾	ASP (mmca) ⁽⁴⁾	Price (€)	
	Series / Model	HP	Power supply	9 °C		12 °C		15 °C													Series / Model
R-134a	ASH-DY-11 015	1/2	230 V-I	1 555	14	1 733	19	1 928	26	0.75	5.9	1 100	1/4"-1/2"	<2.0	48+32	32	3 263	ASH-CDY-11 015	575	8	3 618
	ASH-DY-11 026	3/4	230 V-I	1 985	18	2 221	24	2 462	33	0.99	9.6	1 100	1/4"-1/2"	<2.0	51+32	30	3 527	ASH-CDY-11 026	575	8	3 915
	ASH-DY-11 033	1	230 V-I	2 378	22	2 636	29	2 903	40	1.37	9.8	1 100	1/4"-5/8"	<2.0	51+32	33	3 959	ASH-CDY-11 033	575	8	4 395
	ASH-DY-22 033	1	230 V-I	2 961	28	3 329	38	3 717	51	1.30	10.7	1 800	1/4"-5/8"	<2.5	54+45	34	4 346	ASH-CDY-22 033	1 000	12	4 822
	ASH-DY-22 053	1 1/2	230 V-I *	3 738	35	4 169	48	4 625	63	2.04	13.3	1 800	3/8"-3/4"	<2.5	55+45	38	5 057	ASH-CDY-22 053	1 000	12	5 614
	ASH-DY-33 053	1 1/2	230 V-I *	4 211	42	4 709	56	5 234	76	2.05	13.6	3 150	3/8"-3/4"	<4.0	74+65	39	5 354	ASH-CDY-33 053	1 500	14	5 946
	ASH-DY-33 074	2	230 V-I *	5 502	58	6 148	77	6 830	104	2.74	17.6	3 150	3/8"-3/4"	<4.0	71+65	44	6 372	ASH-CDY-33 074	1 500	14	7 069
	ASH-DY-43 086	4	400 V-III	7 124	74	8 001	98	8 915	131	3.16	15.4	3 150	3/8"-7/8"	<6.5	107+65	48	7 262	ASH-CDY-43 086	3 500	10	8 062
	ASH-DY-43 108	5	400 V-III	8 216	85	9 177	111	10 206	148	3.76	18.4	3 150	3/8"-7/8"	<6.0	109+65	45	7 970	ASH-CDY-43 108	3 500	10	8 846
	ASH-DY-44 108	5	400 V-III	8 873	92	9 954	121	11 062	160	4.08	18.4	5 700	3/8"-7/8"	<6.0	112+70	45	8 734	ASH-CDY-44 108	3 500	10	9 694
ASH-DY-44 136	6 1/2	400 V-III	10 988	114	12 206	148	13 498	195	4.57	22.4	5 700	1/2"-1 1/8"	<6.0	112+70	44	9 607	ASH-CDY-44 136	3 500	10	10 664	
R-449A	ASH-DG-1 010	3/8	230 V-I	1 237	10	1 341	14	1 455	19	0.77	5.2	1 100	1/4"-3/8"	<2.5	42+32	34	2 990	ASH-CDG-1 010	575	8	3 379
	ASH-DG-1 012	1/2	230 V-I	1 419	12	1 535	16	1 664	22	0.82	6.2	1 100	1/4"-3/8"	<2.5	43+32	34	3 117	ASH-CDG-1 012	575	8	3 523
	ASH-DG-2 014	1/2	230 V-I	1 829	16	1 965	22	2 109	29	0.95	7.4	1 100	1/4"-1/2"	<3.0	45+32	35	3 246	ASH-CDG-2 014	1 000	12	3 665
	ASH-DG-2 016	5/8	230 V-I	2 014	18	2 169	24	2 338	33	1.03	8.3	1 100	1/4"-1/2"	<3.0	54+32	35	3 373	ASH-CDG-2 016	1 000	12	3 799
	ASH-DG-2 018	3/4	230 V-I	2 309	22	2 481	28	2 675	38	1.23	9.6	1 100	1/4"-1/2"	<3.0	55+32	35	3 564	ASH-CDG-2 018	1 000	12	3 996
	ASH-DG-2 024	1	230 V-I	2 988	27	3 228	36	3 480	47	1.61	11.8	1 800	3/8"-5/8"	<3.0	55+45	35	4 008	ASH-CDG-2 024	1 000	12	4 454
	ASH-DG-3 026	1 1/4	230 V-I *	3 434	33	3 709	42	3 996	57	1.76	11.7	1 800	3/8"-5/8"	<3.5	74+45	37	4 300	ASH-CDG-3 026	1 500	14	4 822
	ASH-DG-3 034	1 1/2	230 V-I *	4 376	41	4 692	54	5 048	72	2.26	16.5	1 800	3/8"-5/8"	<4.0	74+45	38	4 835	ASH-CDG-3 034	1 850	14	5 368
	ASH-DG-3 038	1 3/4	400 V-III	5 011	47	5 356	62	5 733	85	2.15	7.3	1 800	3/8"-5/8"	<4.0	71+45	40	5 606	ASH-CDG-3 038	1 850	14	6 173
	ASH-DG-4 048	2	400 V-III	6 667	66	7 151	86	7 673	115	2.98	10.2	3 150	1/2"-3/4"	<5.5	95+65	36	6 181	ASH-CDG-4 048	3 500	10	6 765
ASH-DG-4 054	2 1/2	400 V-III	7 362	73	7 875	95	8 446	125	3.23	10.7	3 150	1/2"-3/4"	<6.0	96+65	36	6 559	ASH-CDG-4 054	3 500	10	7 144	
ASH-DG-4 060	3	400 V-III	8 369	82	8 974	105	9 614	140	3.96	12.2	3 800	1/2"-7/8"	<6.0	97+65	36	7 195	ASH-CDG-4 060	3 500	10	7 782	
ASH-DG-4 068	3 1/2	400 V-III	9 113	89	9 753	115	10 442	150	4.47	13.2	3 800	1/2"-7/8"	<6.0	98+65	35	7 886	ASH-CDG-4 068	3 500	10	8 473	

Options

- ▶ Change to 400 V-III-50 Hz power supply. + 5 %
- ▶ Crankcase heater. + 63 €
- ▶ Proportional control of condensing pressure:
Axial version (D): 3/33 and 4/43/44 series. + 262 €
Centrifugal version (CD): 4/43/44 series. + 418 €
- ▶ Vertical air flow (centrifugal version).
- ▶ Rectangular to circular exhaust air adaptor. + 105 €
- ▶ Built-in oil separator. + 617 €
- ▶ Anti-corrosion evaporator coil coating. + 6 %
- ▶ Anti-corrosion condenser coil coating. + 4 %
- ▶ Condensed water pump. + 126 €
- ▶ Larger sized multifunction electronic control. + 157 €

Dimensions

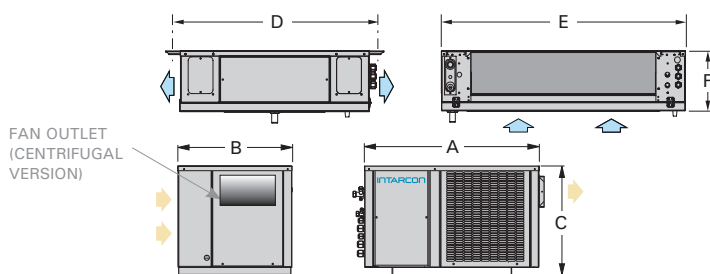

Dimensions (mm)		A	B	C	D	E	F	Evaporator fan	Fan outlet
R-134a	11 series	665	435	416	798	706	245	1x Ø 360	185 x 115
	22 series	835	435	500	798	1 056	245	2x Ø 360	230 x 130
	33 series	925	580	515	798	1 756	245	2x Ø 360	305 x 266
	43 series	1 000	615	585	798	1 756	245	3x Ø 360	305 x 266
	44 series	1 000	615	585	888	2 156	295	3x Ø 450	305 x 266
R-449A	1 series	665	435	416	798	706	245	1x Ø 360	185 x 115
	ASH-DG 2 014 up to 2 018	835	435	500	798	706	245	1x Ø 360	230 x 130
	ASH-DG 2 024	835	435	500	798	1 056	245	2x Ø 360	230 x 130
	3 series	925	580	515	798	1 056	245	2x Ø 360	236 x 266
4 series	1 000	615	585	798	1 756	245	3x Ø 360	305 x 266	

⁽¹⁾ Nominal performances refer to operation with cold room temperatures of 12 °C (HT) and ambient temperature of 35 °C. Estimated cold room volume according to conditions of the calculation bases (page 8).

⁽²⁾ Units with refrigerant load less than 5 tons of CO₂ equivalent (3.5 kg of R-134a or R-449A) exempt from leak checking, Regulation (EU) No 517/2014.

⁽³⁾ Sound pressure in dB (A) in open field at 10 m from the unit.

⁽⁴⁾ Available static pressure of condensation

* Available units with 400 V-III-50 Hz power supply.

Exhaust duct

Recommended size for 20 m long steel, PVC or fibreglass ducts (each elbow at 90° equals 5 m in length). For flexible or semi-flexible ducts use a larger size.

- 0 series: 200 x 150 mm or Ø 150 mm
- 1 series: 200 x 200 mm or Ø 180 mm
- 2 series: 250 x 150 mm or Ø 200 mm
- 3 series: 200 x 300 mm or Ø 250 mm
- 4 and 5 series: 350 x 400 mm or Ø 360 mm

Electrical interconnections

For the interconnection of the condenser and evaporator units, the following cable sections must be provided for a length of 10 m (except series 4, 43 and 44).

Power supply	230 V-I-50 Hz	400 V-III-50 Hz
Probes	4 x 1 mm ²	
Manoeuvre	3 x 1 mm ² + G	
Control pad	2 x 1 mm ²	
Switch door*	2 x 1 mm ²	
Cold room light*	2 x 1 mm ² + G	

* Optional not included. To know electrical interconnections of each model: see technical manual.

Sigilus



Split systems for small and medium size cold rooms at positive and negative temperature, composed of a low-noise condensing unit and a slim-type, cubic-type or double-flow evaporating unit.

Features

- ▶ 230 V-I-50 Hz or 400 V-III-50 Hz power supply. Available in 60 Hz. Others voltages by request.
- ▶ Minimal R-134A or R-449A refrigerant load.
- ▶ Hermetic reciprocating compressor.
- ▶ Double noise compressor insulation.
- ▶ Large surface L-shape condensing coil (straight for series 0 and 1).
- ▶ Low-speed condensing motor fans.
- ▶ Proportional control of condensing pressure (optional for -N version).
- ▶ High and low pressure switches.
- ▶ Discharge muffler (for models 1 HP or more) and crankcase heater.
- ▶ Liquid receiver.
- ▶ Refrigerant pre-load for 10 m of pipe.
- ▶ Evaporating unit: slim-type (-N version) or cubic-type (-Q version).
- ▶ Built-in thermostatic expansion valves and solenoid valves.
- ▶ Electrical heater defrost (except ASF series).
- ▶ Stainless steel drain pan.
- ▶ Flare-type connections (up to 1/2"-3/4") and service valves.
- ▶ MCB protection.
- ▶ Multifunctional electronic control with remote keyboard and digital condensation control.
- ▶ Liquid injection system for negative temperature models with R-449A.

Installation scheme

Maximum vertical distance between units of 15 m if the condensing unit is placed at a higher level than the evaporating unit, and 6 m otherwise.
 * 20 % minimum slope for drain tube for negative temperature models.

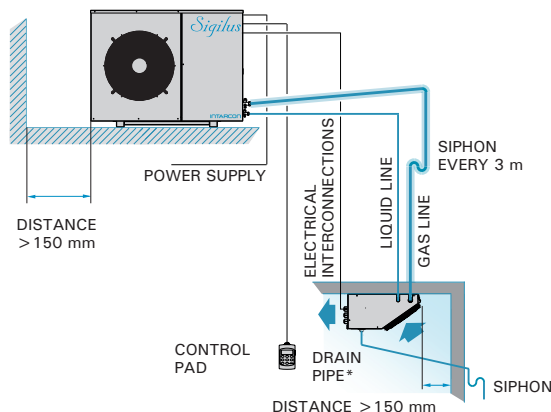

- ❄ Factory-tested systems with no need for on-site tests.
- ❄ Low-noise condensing unit.
- ❄ Tropicalised design for high ambient temperature up to 50 °C.
- ❄ Built-in thermostatic expansion valve.
- ❄ Proportional control of condensing pressure (optional for slim-type).
- ❄ Refrigerant pre-load.
- ❄ Units exempt from leak checks.

Control pad

Sigilus split systems feature XM670K electronic control as standard:



- Remote control keyboard with digital display.
- Temperature control with maximum and minimum temperature value recording.
- Possibility of interconnection and synchronization of up to 8 devices by LAN, managed from a single control.

Triple noise insulation

Sigilus units feature triple noise insulation:

- Noise insulated compressor compartment, separated from the air flow.
- Hermetic reciprocating compressor with insulation cover (three-phase models) and discharge muffler.
- Low-noise and low-speed fan on shock absorbing structure.

Proportional control of condensing pressure

Proportional control of condensing pressure, for prolonged operation at under low ambient temperature, standard for *Sigilus* series (optional for slim-type).

Electrical interconnections

For the interconnection of the condenser and evaporator units, the following cable sections must be provided for a length of 10 m (hoses not included):

Power supply	230 V-I-50 Hz	400 V-III-50 Hz
Probes	4 x 1 mm ²	
Manoeuvre	2 x 1 mm ²	3 x 1 mm ²
Defrost	2 x 1.5 mm ² + G	4 x 1.5 mm ² + G
Control pad	2 x 1 mm ²	
Switch door*	2 x 1 mm ²	
Door heater cable	2 x 1 mm ² at NT	
Cold room light*	2 x 1 mm ² + G	

* Optional not included.
 To know electrical interconnections of each model: see technical manual.

230 V-I-50 Hz / 400 V-III-50 Hz | Positive temperature | R-134a / R-449A

Series / Model	Compressor		Cooling capacity / Cold room volume according to cold room temperature ⁽¹⁾								Input power (kW)	Max. current (A)	Evap. fan	Evap. air flow (m³/h)	Conden. air flow (m³/h)	Liq-Gas cooling connection	Refrig. load (kg) ⁽²⁾	Weight (kg)	SPL dB(A) ⁽³⁾	Price (€)
	HP	Power supply	-5 °C		0 °C		5 °C		10 °C											
			W	m³	W	m³	W	m³	W	m³										
MSF-NY-00 010	3/8	230 V-I	497	2.9	637	5.0	788	8.8	945	13	0.41	4.2	1x Ø 172	300	350	1/4"-3/8"	< 1.5	46+12	28	2 377
MSF-NY-00 015	1/2	230 V-I	653	3.6	832	7.4	1 004	11	1 188	16	0.51	5.2	1x Ø 172	300	350	1/4"-3/8"	< 1.5	49+12	29	2 621
MSF-NY-11 015	1/2	230 V-I	805	4.7	1 031	10	1 296	14	1 582	28	0.56	5.6	1x Ø 200	550	1 700	1/4"-1/2"	< 2.0	57+16	34	2 743
MSF-NY-11 026	3/4	230 V-I	1 076	9.0	1 412	16	1 738	25	2 084	40	0.80	9.2	1x Ø 200	550	1 700	1/4"-1/2"	< 2.0	65+16	34	3 332
MSF-NY-12 033	1	230 V-I	1 475	13	1 859	20	2 289	35	2 741	57	1.02	9.7	2x Ø 200	1 050	1 700	1/4"-5/8"	< 2.0	67+24	34	4 164
MSF-NY-12 053	1 1/2	230 V-I *	1 811	22	2 347	33	2 872	50	3 439	79	1.42	12.3	2x Ø 200	1 050	1 700	1/4"-5/8"	< 2.0	77+24	35	4 882
MSF-NY-13 074	2	230 V-I *	2 772	30	3 528	50	4 363	76	5 229	125	1.94	17.2	3x Ø 254	1 725	1 700	1/4"-3/4"	< 3.5	79+45	37	5 316
MSF-NY-23 086	4	400 V-III	3 355	39	4 384	65	5 376	108	6 437	160	2.18	14.1	3x Ø 254	1 725	3 700	3/8"-7/8"	< 4.5	96+45	38	5 918
MSF-NY-24 108	5	400 V-III	4 347	58	5 649	90	6 920	138	8 316	220	2.83	18.2	4x Ø 300	3 100	3 700	3/8"-7/8"	< 5.0	98+45	35	6 958
MSF-NY-24 136	6 1/2	400 V-III	5 486	75	6 899	110	8 363	150	9 949	280	3.55	22.2	4x Ø 300	3 100	3 700	3/8"-1 1/8"	< 5.5	101+55	34	8 695
MSF-NY-34 171	8	400 V-III	6 080	88	7 613	130	9 240	200	10 978	350	4.16	25.2	4x Ø 300	3 100	4 000	3/8"-1 1/8"	< 5.5	140+55	40	9 910
MSF-NG-0 008	1/3	230 V-I	611	2.9	759	5.0	915	8.8	1 103	13	0.43	5.1	1x Ø 172	300	350	1/4"-3/8"	< 1.5	47+12	29	2 239
MSF-NG-0 010	3/8	230 V-I	739	3.6	894	6.1	1 056	10	1 254	15	0.53	4.8	1x Ø 172	300	350	1/4"-3/8"	< 1.5	49+12	29	2 469
MSF-NG-0 012	1/2	230 V-I	818	4.7	981	7.4	1 153	12	1 358	21	0.63	5.6	1x Ø 172	300	350	1/4"-3/8"	< 1.5	50+12	29	2 584
MSF-NG-1 014	1/2	230 V-I	882	8.0	1 095	12	1 322	20	1 585	34	0.77	6.5	1x Ø 200	550	1 700	1/4"-1/2"	< 2.0	59+16	34	2 882
MSF-NG-1 016	5/8	230 V-I	972	10	1 210	15	1 462	24	1 759	40	0.81	7.4	1x Ø 200	550	1 700	1/4"-1/2"	< 2.0	67+16	34	3 140
MSF-NG-1 018	3/4	230 V-I	1 397	12	1 649	19	1 915	28	2 245	45	0.94	8.7	1x Ø 200	550	1 700	1/4"-1/2"	< 2.0	68+16	34	3 490
MSF-NG-2 024	1	230 V-I	1 513	14	1 958	22	2 420	35	2 958	57	1.26	11.1	2x Ø 200	1 050	1 700	1/4"-1/2"	< 2.5	82+24	34	3 923
MSF-NG-2 026	1 1/4	230 V-I *	1 712	16	2 147	25	2 611	39	3 157	64	1.44	11.5	2x Ø 200	1 050	1 700	1/4"-1/2"	< 2.5	83+24	34	4 099
MSF-NG-2 034	1 1/2	230 V-I *	2 120	21	2 606	33	3 117	50	3 730	79	1.83	16.1	2x Ø 200	1 050	1 700	1/4"-5/8"	< 2.5	83+24	35	4 344
MSF-NG-3 038	1 3/4	400 V-III	2 770	29	3 394	46	4 078	71	4 894	112	1.89	8.1	3x Ø 254	1 725	3 200	1/4"-5/8"	< 3.0	82+45	29	4 917
MSF-NG-4 048	2	400 V-III	3 368	39	4 231	62	5 158	92	6 225	145	2.34	9.6	3x Ø 254	1 725	3 700	3/8"-3/4"	< 4.5	84+45	26	5 344
MSF-NG-4 054	2 1/2	400 V-III	3 792	47	4 671	70	5 640	105	6 780	160	2.54	10.1	3x Ø 254	1 725	3 700	3/8"-3/4"	< 4.5	85+45	26	5 708

230 V-I-50 Hz / 400 V-III-50 Hz | Negative temperature | R-449A

Series / Model	Compressor		Cooling capacity / Cold room volume according to cold room temperature ⁽¹⁾				Input power (kW)	Max. current (A)	Evap. fan	Evap. air flow (m³/h)	Conden. air flow (m³/h)	Liq-Gas cooling connection	Refrig. load (kg) ⁽²⁾	Weight (kg)	SPL dB(A) ⁽³⁾	Price (€)		
	HP	Power supply	-25 °C		-20 °C												-15 °C	
			W	m³	W	m³											W	m³
BSF-NG-0 018	5/8	230 V-I	486	1.1	613	2.3	749	4.1	0.50	4.7	1x Ø 172	300	350	1/4"-1/2"	< 1.5	50+12	28	2 900
BSF-NG-1 026	3/4	230 V-I	763	3.2	952	7.0	1 155	13	0.82	8.5	1x Ø 200	550	1 700	1/4"-1/2"	< 2.0	67+16	34	3 531
BSF-NG-2 034	1 1/4	230 V-I	930	3.9	1 107	8.1	1 437	15	1.18	11.3	2x Ø 200	1 050	1 700	1/4"-1/2"	< 2.0	83+16	34	3 747
BSF-NG-2 055	1 3/4	230 V-I *	1 260	9.0	1 710	16	2 190	30	1.70	17.5	2x Ø 200	1 050	1 700	1/4"-5/8"	< 2.5	85+24	36	4 588
BSF-NG-2 075	2 1/2	230 V-I *	1 655	13	2 130	22	2 625	38	2.10	25.5	2x Ø 200	1 050	1 700	1/4"-5/8"	< 3.5	90+24	37	4 834
BSF-NG-3 075	2 1/2	230 V-I *	1 755	14	2 450	27	3 080	48	2.30	26.3	3x Ø 254	1 725	1 700	1/4"-5/8"	< 3.5	90+45	37	5 184
BSF-NG-4 096	3 1/2	400 V-III	2 139	19	2 670	39	3 523	68	2.48	12.0	3x Ø 254	1 725	3 700	3/8"-3/4"	< 4.5	97+45	39	6 719
BSF-NG-4 108	4 1/4	400 V-III	2 463	29	3 276	50	4 118	78	2.82	14.6	3x Ø 254	1 725	3 700	3/8"-7/8"	< 5.0	97+45	37	7 274
BSF-NG-4 136	5	400 V-III	2 949	37	3 775	61	4 648	100	3.64	16.8	3x Ø 254	1 725	3 700	3/8"-7/8"	< 5.0	100+45	32	7 847

Options

- ▶ Change to 400 V-III-50 Hz power supply. + 5 %
- ▶ Proportional control of condensing pressure through fan speed variation (except O series). + 262 €
- ▶ Coil protection grille. + 95 €
- ▶ Built-in oil separator. + 617 €
- ▶ Anti-corrosion evaporator coil coating. + 6 %
- ▶ Anti-corrosion condenser coil coating. + 4 %
- ▶ Larger sized multifunction electronic control. + 157 €

⁽¹⁾ Nominal performances refer to operation with cold room temperatures of 0 °C (PT) and -20 °C (NT), and ambient temperature of 35 °C. Estimated cold room volume according to conditions of the calculation bases (page 8).

⁽²⁾ Units with refrigerant load less than 5 tons of CO₂ equivalent (3.5 kg of R-134a or R-449A) exempt from leak checking, Regulation (EU) No 517/2014.

⁽³⁾ Sound pressure in dB (A) in open field at 10 m from the unit.

* Available units with 400 V-III-50 Hz power supply.

Dimensions

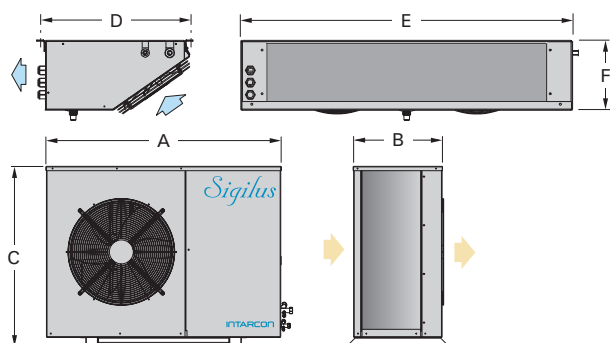

Dimensions (mm)	A	B	C	D	E	F	Evaporator fans
0 and 00 series	670	308	450	417	563	150	1x Ø 172
1 and 11 series	1 030	375	580	430	643	200	1x Ø 200
2 and 12 series	1 030	375	580	430	993	200	2x Ø 200
3 and 13 series	1 030	375	580	508	1 691	200	3x Ø 254
4 and 23 series	1 080	415	830	508	1 691	200	3x Ø 254
24 series	1 080	415	830	547	2 064	250	4x Ø 300
34 series	1 150	480	1 100	547	2 064	250	4x Ø 300

230 V-I-50 Hz / 400 V-III-50 Hz | **Positive temperature** | R-134a / R-449A

Series / Model	Compressor		Cooling capacity / Cold room volume according to cold room temperature ⁽¹⁾								Input power (kW)	Max. current (A)	Fan evap.	Evap. air flow (m ³ /h)	Conden. air flow (m ³ /h)	Liq-Gas cooling connection	Refrig. load (kg) ⁽²⁾	Weight (kg)	SPL dB(A) ⁽³⁾	Price (€)	
	HP	Power supply	-5 °C		0 °C		5 °C		10 °C												
			W	m ³	W	m ³	W	m ³	W	m ³											
R-134a	MSF-QY-10 068	3 1/2	400 V-III	3 281	42	4 106	60	4 998	69	5 985	110	1.98	12.8	1x Ø 350	2 100	3 200	1/4"-3/4"	< 4.0	82+43	25	6 366
	MSF-QY-20 086	4	400 V-III	3 523	45	4 442	65	5 429	75	6 515	120	2.19	14.8	1x Ø 350	2 100	3 700	3/8"-7/8"	< 4.5	96+43	38	6 889
	MSF-QY-21 108	5	400 V-III	4 226	58	5 334	81	6 521	130	7 807	210	2.56	16.3	1x Ø 350	2 700	3 700	3/8"-7/8"	< 5.0	98+56	35	7 512
	MSF-QY-22 136	6 1/2	400 V-III	5 749	80	7 277	120	8 831	186	10 553	290	3.63	21.1	2x Ø 350	4 150	3 700	3/8"-1 1/8"	< 5.0	101+72	34	9 054
	MSF-QY-33 171	8	400 V-III	6 746	100	8 484	172	10 295	197	12 306	354	4.42	24.1	2x Ø 350	5 200	4 000	3/8"-1 1/8"	< 7.0	140+89	40	10 319
	MSF-QY-33 215	10	400 V-III	8 426	130	10 563	241	12 857	268	15 419	440	5.24	30.5	3x Ø 350	6 200	6 500	3/8"-1 1/8"	< 7.5	147+94	39	11 358
	MSF-QY-34 271	13	400 V-III	11 099	165	13 776	256	16 622	346	19 777	550	7.19	40.2	4x Ø 350	8 300	6 500	1/2"-1 3/8"	< 8.5	152+118	38	14 384
R-449A	MSF-QG-10 038	1 3/4	400 V-III	3 280	31	3 919	48	4 625	75	5 472	120	1.77	7.4	1x Ø 350	2 100	3 200	1/4"-5/8"	< 3.0	82+43	29	5 694
	MSF-QG-20 048	2	400 V-III	3 964	43	4 736	63	5 572	95	6 605	150	2.21	8.8	1x Ø 350	2 100	3 700	3/8"-3/4"	< 5.0	84+43	26	6 160
	MSF-QG-20 054	2 1/2	400 V-III	4 395	48	5 197	72	6 078	110	7 158	170	2.38	9.4	1x Ø 350	2 100	3 700	3/8"-3/4"	< 5.0	85+43	26	6 426
	MSF-QG-21 060	3	400 V-III	5 081	61	6 032	89	7 055	130	8 328	200	2.84	10.4	1x Ø 350	2 700	3 700	3/8"-3/4"	< 5.0	88+56	26	7 008
	MSF-QG-21 068	3 1/2	400 V-III	5 519	78	6 528	110	7 601	160	8 942	250	3.21	11.4	1x Ø 350	2 700	3 700	3/8"-3/4"	< 5.0	88+56	25	8 097
	MSF-QG-32 086	4	400 V-III	6 787	91	8 180	130	9 707	190	11 545	300	4.13	13.6	2x Ø 350	4 150	4 000	1/2"-7/8"	< 7.0	115+72	38	9 228
	MSF-QG-32 108	5	400 V-III	8 623	125	10 181	175	11 880	255	13 969	400	5.05	16.7	2x Ø 350	4 150	6 500	1/2"-7/8"	< 7.0	120+72	35	10 157
	MSF-QG-43 136	6 1/2	400 V-III	11 105	160	13 146	220	15 399	320	18 145	500	6.63	21.5	3x Ø 350	6 200	7 000	1/2"-1 1/8"	< 10.0	135+89	34	12 081
	MSF-QG-44 160	8	400 V-III	11 597	170	14 009	230	16 660	340	19 806	530	7.59	26.0	4x Ø 350	8 300	7 000	5/8"-1 1/8"	< 10.0	157+118	40	14 180

230 V-I-50 Hz / 400 V-III-50 Hz | **Negative temperature** | R-449A

Series / Model	Compressor		Cooling capacity / Cold room volume according to cold room temperature ⁽¹⁾						Input power (kW)	Max. current (A)	Fan evap.	Evap. air flow (m ³ /h)	Conden. air flow (m ³ /h)	Liq-Gas cooling connection	Refrig. load (kg) ⁽²⁾	Weight (kg)	SPL dB(A) ⁽³⁾	Price (€)	
	HP	Power supply	-25 °C		-20 °C		-15 °C												
			W	m ³	W	m ³	W	m ³											
R-449A	BSF-QG-10 075	2 1/2	230 V-I *	1 760	14	2 465	27	3 110	48	2.30	25.1	1x Ø 350	2 100	1 700	1/4"-5/8"	< 3.0	90+43	37	5 581
	BSF-QG-20 096	3 1/2	400 V-III	2 456	20	3 135	43	3 881	74	2.39	11.5	1x Ø 350	2 100	3 700	1/4"-3/4"	< 4.0	97+43	39	7 597
	BSF-QG-21 108	4 1/4	400 V-III	3 023	28	3 883	50	4 772	86	2.76	13.5	1x Ø 350	2 700	3 700	1/4"-7/8"	< 5.0	97+56	37	8 178
	BSF-QG-22 136	5	400 V-III	4 159	53	5 116	83	6 146	130	4.02	16.4	2x Ø 350	4 150	3 700	3/8"-1 1/8"	< 5.0	97+72	32	9 727
	BSF-QG-33 215	7 1/2	400 V-III	5 970	80	7 605	130	9 334	200	5.63	25.8	3x Ø 350	6 200	6 500	1/2"-1 1/8"	< 7.5	147+94	39	12 295
	BSF-QG-34 271	10	400 V-III	8 005	120	9 839	185	11 798	230	7.15	28.2	4x Ø 350	8 300	6 500	1/2"-1 3/8"	< 8.5	147+118	39	13 770

Options

- ▶ Change to 400 V-III-50 Hz power supply. + 5 %
- ▶ Coil protection grille. + 95 €
- ▶ Built-in oil separator. + 617 €
- ▶ Anti-corrosion evaporator coil coating. + 6 %
- ▶ Anti-corrosion condenser coil coating. + 4 %
- ▶ Larger sized multifunction electronic control. + 157 €

Dimensions

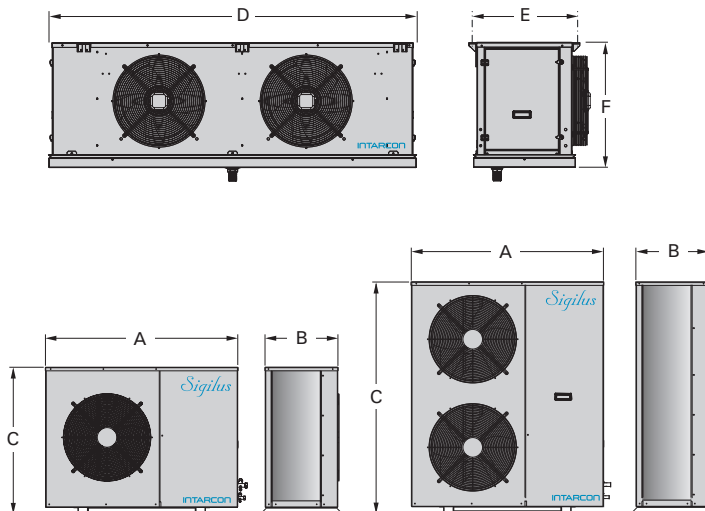

⁽¹⁾ Nominal performances refer to operation with cold room temperatures of 0 °C (PT) and -20 °C (NT), and ambient temperature of 35 °C. Estimated cold room volume according to conditions of the calculation bases (page 8).

⁽²⁾ Units with refrigerant load less than 5 tons of CO₂ equivalent (3.5 kg of R-134a or R-449A) exempt from leak checking, Regulation (EU) No 517/2014.

⁽³⁾ Sound pressure in dB (A) in open field at 10 m from the unit.

* Available units with 400 V-III-50 Hz power supply.

Electrical interconnections

For the interconnection of the condenser and evaporator units, the following cable sections must be provided for a length of 10 m (except series 43 and 44).

Power supply	230 V-I-50 Hz	400 V-III-50 Hz
Probes	4 x 1 mm ²	
Manoeuvre	2 x 1 mm ²	3 x 1 mm ²
Defrost	2 x 1.5 mm ² + G	4 x 1.5 mm ² + G
Control pad	2 x 1 mm ²	
Switch door*	2 x 1 mm ²	
Door heater cable	2 x 1 mm ² at NT	
Cold room light*	2 x 1 mm ² + G	

* Optional not included.

To know electrical interconnections of each model: see technical manual.

Dimensions (mm)	A	B	C	D	E	F
10 series	1 030	375	580	881	455	553
20 series	1 080	415	830	881	455	553
21 series	1 080	415	830	1 231	455	553
22 series	1 080	415	830	1 531	455	553
32 series	1 150	480	1 100	1 531	455	553
33 series	1 150	480	1 100	1 932	455	553
34 series	1 150	480	1 100	2 432	455	553
43 series	1 150	480	1 350	1 932	455	553
44 series	1 150	480	1 350	2 432	455	553

230 V-I-50 Hz / 400 V-III-50 Hz | High temperature | R-134a / R-449A

Series / Model	Compressor		Cooling capacity / Cold room volume according to cold room temperature ⁽¹⁾						Input power (kW)	Max. current (A)	Evap. air flow (m ³ /h)	Conden. air flow (m ³ /h)	Liq-Gas cooling connection	Refrig. load (kg) ⁽²⁾	Weight (kg)	SPL dB(A) ⁽³⁾	Price (€)	
	HP	Power supply	9 °C		12 °C		15 °C											
			W	m ³	W	m ³	W	m ³										
R-134a	ASF-DY-11 015	1/2	230 V-I	1 687	16	1 922	21	2 160	29	0.69	4.7	1 100	1 700	1/4"-1/2"	<2.5	57+32	34	3 771
	ASF-DY-11 026	3/4	230 V-I	2 342	23	2 678	30	2 977	41	1.05	8.4	1 100	1 700	1/4"-1/2"	<2.5	65+32	34	4 040
	ASF-DY-12 033	1	230 V-I	2 840	27	3 176	36	3 533	48	1.33	10.4	1 800	1 700	1/4"-5/8"	<3.0	67+45	34	4 547
	ASF-DY-13 053	1 1/2	230 V-I *	4 226	42	4 730	56	5 271	72	2.04	13.6	3 150	1 700	3/8"-3/4"	<4.0	77+65	35	5 717
	ASF-DY-13 074	2	230 V-I *	6 053	62	6 825	83	7 634	112	2.61	17.6	3 150	3 200	3/8"-3/4"	<4.5	79+65	34	6 645
	ASF-DY-23 086	4	400 V-III	7 151	75	8 033	99	8 957	131	2.90	14.4	3 150	3 700	3/8"-7/8"	<5.0	96+65	38	7 436
	ASF-DY-24 108	5	400 V-III	8 936	99	10 028	122	11 146	165	3.80	17.5	5 700	3 700	3/8"-7/8"	<5.5	98+70	35	8 245
	ASF-DY-24 136	6 1/2	400 V-III	11 093	128	12 332	168	13 645	224	5.00	21.2	5 700	3 700	1/2"-1 1/8"	<6.0	98+70	34	10 526
	ASF-DY-34 171	8	400 V-III	13 424	146	14 989	186	16 669	251	5.88	25.2	5 700	6 500	1/2"-1 1/8"	<6.0	120+70	40	12 518
R-449A	ASF-DY-44 215	10	400 V-III	15 771	171	17 593	218	19 546	294	6.61	30.2	5 700	7 000	1/2"-1 3/8"	<9.5	120+70	39	13 767
	ASF-DG-1 016	5/8	230 V-I	2 161	19	2 387	25	2 635	35	0.99	7.5	1 100	1 700	1/4"-1/2"	<2.5	67+32	38	3 604
	ASF-DG-1 018	3/4	230 V-I	2 462	23	2 709	30	2 961	42	1.18	8.8	1 100	1 700	1/4"-1/2"	<2.5	68+32	35	3 863
	ASF-DG-1 024	1	230 V-I	3 225	29	3 539	39	3 879	51	1.53	11.3	1 800	1 700	3/8"-5/8"	<3.5	82+45	34	4 347
	ASF-DG-1 026	1 1/4	230 V-I *	3 709	35	4 078	46	4 466	63	1.75	12.0	1 800	3 200	3/8"-5/8"	<3.5	83+45	40	4 543
	ASF-DG-1 034	1 1/2	230 V-I *	4 607	43	5 046	58	5 494	77	2.24	16.6	1 800	3 200	3/8"-5/8"	<3.5	83+45	39	5 159
	ASF-DG-1 038	1 3/4	400 V-III	5 393	52	5 885	68	6 410	91	2.20	7.8	3 150	3 200	3/8"-5/8"	<4.0	82+65	29	5 835
	ASF-DG-2 048	2	400 V-III	6 722	67	7 343	87	7 962	115	2.76	9.3	3 150	3 700	1/2"-3/4"	<5.5	84+65	26	6 461
	ASF-DG-2 054	2 1/2	400 V-III	7 447	75	8 113	97	8 793	130	3.00	9.8	3 150	3 700	1/2"-3/4"	<5.5	85+65	26	6 714
	ASF-DG-3 060	3	400 V-III	8 824	94	9 673	115	10 551	155	3.60	11.9	3 150	6 500	1/2"-7/8"	<6.0	88+65	26	7 442
ASF-DG-3 068	3 1/2	400 V-III	9 662	98	10 578	125	11 512	165	4.19	12.9	3 150	6 500	1/2"-7/8"	<6.0	88+65	25	8 772	
ASF-DG-4 086	4	400 V-III	11 687	120	12 829	155	14 001	205	4.90	15.2	5 700	7 000	5/8"-1 1/8"	<9.0	115+70	38	10 237	
ASF-DG-4 108	5	400 V-III	14 416	150	15 702	190	17 068	255	6.40	18.2	5 700	7 000	5/8"-1 1/8"	<8.5	120+70	35	11 301	

Options

- ▶ Change to 400 V-III-50 Hz power supply. + 5 %
- ▶ Proportional control of condensing pressure through fan speed variation (already included in 2/23 series and above). + 262 €
- ▶ Coil protection grille. + 95 €
- ▶ Built-in oil separator. + 617 €
- ▶ Anti-corrosion evaporator coil coating. + 6 %
- ▶ Anti-corrosion condenser coil coating. + 4 %
- ▶ Condensed water pump. + 126 €
- ▶ Larger sized multifunction electronic control. + 157 €

⁽¹⁾ Nominal performances refer to operation with cold room temperatures of 12 °C (HT) ambient temperature of 35 °C. Estimated cold room volume according to conditions of the calculation bases (page 8).

⁽²⁾ Units with refrigerant load less than 5 tons of CO₂ equivalent (3.5 kg of R-134a or R-449A) exempt from leak checking, Regulation (EU) No 517/2014.

⁽³⁾ Sound pressure in dB (A) in open field at 10 m from the unit.

* Available units with 400 V-III-50 Hz power supply.

Electrical interconnections

For the interconnection of the condenser and evaporator units, the following cable sections must be provided for a length of 10 m (except series 4 and 44).

Power supply	230 V-I-50 Hz	400 V-III-50 Hz
Probes	4 x 1 mm ²	
Manoeuvre	3 x 1 mm ² + G	5 x 1 mm ² + G
Control pad	2 x 1 mm ²	
Condensed water pump*	3 x 1 mm ²	

* Optional not included. To know electrical interconnections of each model: see technical manual.

Dimensions

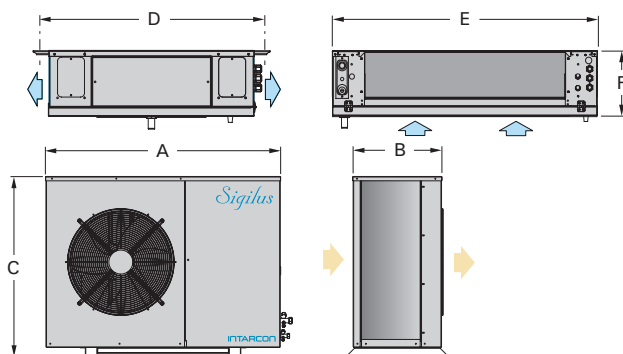

Dimensions (mm)		A	B	C	D	E	F	Evaporator fans
R-134a	11 series	1 030	375	580	798	706	245	1x Ø 360
	12 series	1 030	375	580	798	1 056	245	2x Ø 360
	13 series	1 030	375	580	798	1 756	245	3x Ø 360
	23 series	1 080	415	830	798	1 756	245	3x Ø 360
	24 series	1 080	415	830	888	2 156	295	3x Ø 450
	34 series	1 150	480	1 100	888	2 156	295	3x Ø 450
	44 series	1 150	480	1 350	888	2 156	295	3x Ø 450
R-449A	ASF-DG-1 016 and 1 018	1 030	375	580	798	706	245	1x Ø 360
	ASF-DG-1 024 up to 1 034	1 030	375	580	798	1 056	245	2x Ø 360
	ASF-DG-1 038	1 030	375	580	798	1 756	245	3x Ø 360
	2 series	1 080	415	830	798	1 756	245	3x Ø 360
	3 series	1 150	480	1 100	798	1 756	245	3x Ø 360
4 series	1 150	480	1 350	888	2 156	295	3x Ø 450	

System for meat preservation and maturation



Split refrigeration systems for positive temperature applications, featuring a quasi-static evaporating unit with double air flow, and an axial low-noise or centrifugal condensing unit.

Features

- ▶ 230 V-I-50 Hz or 400 V-III-50 Hz power supply. Available in 60 Hz. Others voltages by request.
- ▶ Minimal R-134a or R-449A refrigerant load.
- ▶ Hermetic reciprocating compressor.
- ▶ Quasi-static evaporating unit with double air flow and axial motor fans at very low speed.
- ▶ High and low pressure switches.
- ▶ Built-in solenoid valve.
- ▶ Built-in thermostatic expansion valve.
- ▶ Electrical heater defrost.
- ▶ Stainless steel drain pan.
- ▶ Flare-type connections (up to 1/2"-3/4") and service valves.
- ▶ MCB protection.
- ▶ Liquid receiver.
- ▶ Refrigerant pre-load for 10 m piping.
- ▶ Multifunction electronic control with remote keyboard and digital regulation of condensing pressure.

Series

- ▶ **MSF-U:** Split systems with low-noise condensing unit and quasi-static double-flow evaporating unit.
- ▶ **MSH-CU:** Split systems with centrifugal condensing unit and quasi-static double-flow evaporating unit.

Installation scheme

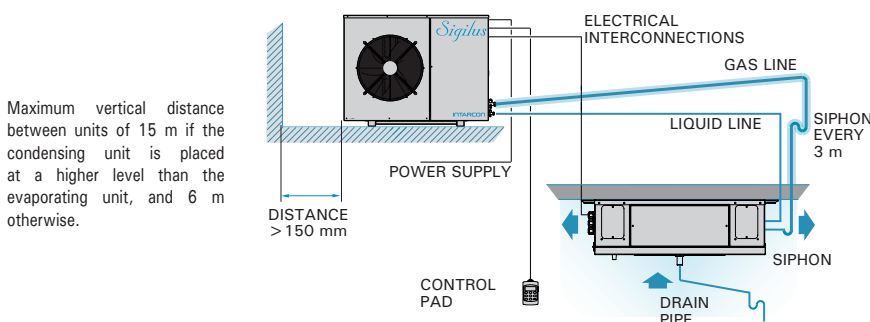

- ❄️ Quasi-static double-flow evaporating unit for very low air speed, specially designed for meat preservation.
- ❄️ Factory-tested systems with no need for on-site tests.
- ❄️ Refrigerant pre-load.
- ❄️ Units exempt from leak checks.

Meat preservation

Quasi-static split systems are specifically recommended for unpacked meat preservation in cold rooms at temperature around 0 °C.

Double airflow evaporating units feature fans operating at a minimum speed to emulate the natural air convection inside the cold room, just as in a static evaporating unit.

Minimum air speed prevents moisture loss from the stored goods and keeps the correct level of humidity inside the cold room to prevent bacterial growth on the meat surface.



Meat maturation (optional)

Maturation of meat requires the control of the relative humidity of the cold room in a certain range.

Units for maturation of meat, are configured for cold rooms in the environment of 0 °C and in the range of 40 % to 95 % of relative humidity.

These units incorporate an advanced electronic regulation to control of the temperature and humidity inside the cold room, with dehumidification and humidification and functions with steam humidification of 3 kg / h capacity, consisting of: steam lances integrated in the evaporator unit, a submerged electrode generating cylinder with feed and water purge valves, and electronic relative humidity controller in the cold room.



Crankcase heater

As standard on *Sigilus* MSF units and optional on MSH series. Its inclusion in outdoor units is recommended.

230 V-I-50 Hz / 400 V-III-50 Hz | Positive temperature - Meat preservation and maturation | R-134a / R-449A

Series / Model	Compressor		Cooling capacity / Cold room volume according to cold room temperature ⁽¹⁾								Input power (kW)	Max. current (A)	Evap. air flow (m³/h)	Conden. air flow (m³/h)	Liq-Gas Cooling Connection	Refrig. load (kg) ⁽²⁾	Weight (kg)	SPL dB(A) ⁽³⁾	Price (€)
	HP	Power supply	-5 °C		0 °C		5 °C		10 °C										
			W	m³	W	m³	W	m³	W	m³									
MSF-UY-11 026	3/4	230 V-I	1 145	7,6	1 449	15	1 785	24	2 153	41	0.83	9.4	600	1 700	1/4"-1/2"	<2.0	65+32	34	3 829
MSF-UY-12 033	1	230 V-I	1 428	12	1 764	20	2 147	34	2 562	53	0.96	10.0	700	1 700	1/4"-5/8"	<3.0	67+45	34	4 563
MSF-UY-13 053	1 1/2	230 V-I *	2 100	22	2 657	40	3 255	56	3 938	86	1.50	12.6	1 325	1 700	1/4"-3/4"	<3.5	77+65	35	5 702
MSF-UY-13 074	2	230 V-I *	2 741	30	3 434	48	4 190	74	5 009	120	1.86	16.9	1 325	1 700	1/4"-3/4"	<4.5	79+65	37	6 517
MSF-UY-23 086	4	400 V-III	3 308	40	4 158	62	5 114	99	6 132	154	2.08	13.4	1 325	3 700	3/8"-7/8"	<5.5	96+65	38	7 125
MSF-UY-24 108	5	400 V-III	4 431	54	5 576	87	6 825	134	8 243	209	2.74	16.9	2 600	3 700	3/8"-7/8"	<7.5	98+65	38	8 140
MSF-UY-24 136	6 1/2	400 V-III	5 444	72	6 815	108	8 306	162	10 038	268	3.44	20.9	2 600	3 700	3/8"-1 1/8"	<7.5	101+65	34	9 139
MSF-UY-34 171	8	400 V-III	11 151	153	7 539	123	9 293	181	11 146	299	4.06	23.9	2 600	4 000	3/8"-1 1/8"	<8.0	140+65	40	10 829
MSF-UG-1 016	5/8	230 V-I	1 215	9,5	1 483	15	1 772	25	2 101	40	0.89	7.5	600	1 700	1/4"-1/2"	<2.5	67+32	34	3 643
MSF-UG-1 018	3/4	230 V-I	1 421	12	1 720	19	2 050	30	2 410	48	1.03	8.8	600	1 700	1/4"-1/2"	<2.5	68+32	34	4 186
MSF-UG-1 024	1	230 V-I	1 648	15	1 998	24	2 390	37	2 812	59	1.19	11.0	700	1 700	3/8"-5/8"	<3.5	82+43	34	4 495
MSF-UG-1 034	1 1/2	230 V-I *	2 235	23	2 699	35	3 193	54	3 739	84	1.84	16.0	700	1 700	3/8"-5/8"	<3.5	83+43	35	5 125
MSF-UG-1 038	1 3/4	400 V-III	2 833	31	3 451	47	4 130	72	4 882	115	1.85	7.4	1 325	3 200	3/8"-5/8"	<4.5	82+63	29	5 997
MSF-UG-2 054	2 1/2	400 V-III	3 784	47	4 600	70	5 447	105	6 426	160	2.38	9.4	1 325	3 700	3/8"-3/4"	<5.0	85+63	26	6 641
MSF-UG-2 068	3 1/2	400 V-III	4 825	64	5 794	93	6 834	135	8 017	205	3.35	11.4	1 325	3 700	1/2"-3/4"	<7.0	88+63	25	8 211
MSF-UG-3 086	4	400 V-III	6 027	83	7 257	120	8 579	175	10 060	270	4.23	13.9	2 600	4 000	1/2"-7/8"	<7.0	115+66	38	9 729

Options

- ▶ Change to 400 V-III-50 Hz power supply. + 5 %
- ▶ Proportional control of condensing pressure through fan speed variation (already included in 2/23 series and above). + 262 €
- ▶ Coil protection grille. + 95 €
- ▶ Built-in oil separator. + 617 €
- ▶ Condenser coil polyurethane anti-corrosion treatment. + 4 %
- ▶ Control for maturation of meat with humidification and dehumidification functions. By request
- ▷ Touch screen display. By request

Dimensions

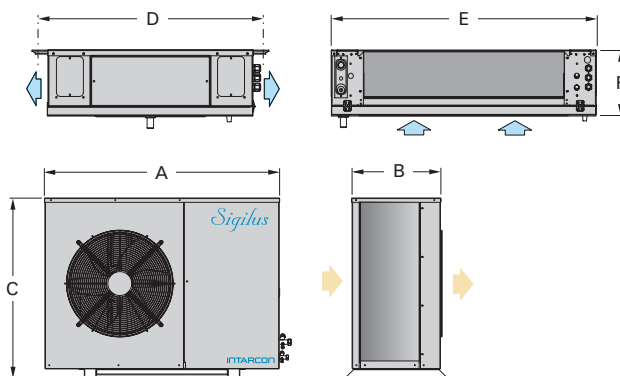

Dimensions (mm)		A	B	C	D	E	F	Evaporator fans
R-134a	11 series	1 030	373	577	798	706	245	1x Ø 360
	12 series	1 030	373	577	798	1 056	245	1x Ø 360
	13 series	1 030	373	577	798	1 756	245	2x Ø 360
	23 series	1 080	410	827	798	1 756	245	2x Ø 360
	24 series	1 080	410	827	888	2 156	295	2x Ø 450
	34 series	1 150	481	1 097	888	2 156	295	2x Ø 450
R-449A	MSF-UG-1 016 and 1 018	1 030	373	577	798	706	245	1x Ø 360
	MSF-UG-1 024 and 1 034	1 030	373	577	798	1 056	245	1x Ø 360
	MSF-UG-1 038	1 030	373	577	798	1 756	245	2x Ø 360
	MSF-UG-2 054 and 2 068	1 080	410	827	798	1 756	245	2x Ø 360
	MSF-UG-3 086	1 150	481	1 097	888	2 156	295	2x Ø 450

⁽¹⁾ Nominal performances refer to operation with cold room temperatures of 0 °C and ambient temperature of 35 °C. Estimated cold room volume according to conditions of the calculation bases (page 8).

⁽²⁾ Units with refrigerant load less than 5 tons of CO₂ equivalent (3.5 kg of R-134a or R-449A) exempt from leak checking, Regulation (EU) No 517/2014.

⁽³⁾ Sound pressure in dB (A) in open field at 10 m from the unit.

* Available units with 400 V-III-50 Hz power supply.

Centrifugal version (MSH-CU series)

Quasi-static split systems are also available with centrifugal condensing units.

Series / Model	HP	Cooling capacity		Price (€)
		0 °C / 35 °C	W m³	
MSH-CUY-11 026	3/4	1 281	12	3 597
MSH-CUY-11 033	1	1 517	15	4 375
MSH-CUY-22 033	1	1 811	22	4 672
MSH-CUY-22 053	1 1/2	2 174	28	5 153
MSH-CUY-33 053	1 1/2	2 657	35	5 648
MSH-CUY-33 074	2	3 402	47	6 322
MSH-CUY-43 086	4	4 153	70	7 604
MSH-CUY-43 108	5	5 219	84	8 307
MSH-CUY-44 108	5	5 555	89	8 945
MSH-CUY-44 136	6 1/2	6 773	108	11 089
MSH-CUG-1 016	5/8	1 349	13	3 422
MSH-CUG-1 018	3/4	1 545	16	4 162
MSH-CUG-2 024	1	1 978	23	4 445
MSH-CUG-2 034	1 1/2	2 627	34	5 075
MSH-CUG-3 038	1 3/4	3 265	44	5 821
MSH-CUG-4 054	2 1/4	4 590	69	6 831
MSH-CUG-4 068	3 1/2	5 783	93	8 033

Condensing units features as in pages 21 up to 22.

Electrical interconnections

For the interconnection of the condenser and evaporator units, the following cable sections must be provided for a length of 10 m.

Power supply	230 V-I-50 Hz	400 V-III-50 Hz
Probes	4 x 1 mm²	
Manoeuvre	2 x 1 mm²	3 x 1 mm²
Defrost	2 x 1.5 mm² + G	4 x 1.5 mm² + G
Control pad	2 x 1 mm²	
Switch door*	2 x 1 mm²	
Cold room light*	2 x 1 mm² + G	

* Optional not included. To know electrical interconnections of each model: see technical manual.

High humidity



Split refrigeration systems for high relative humidity applications in a positive temperature range, featuring an evaporating unit with double air flow, and a low-noise or centrifugal condensing unit.

Features

- ▶ 230 V-I-50 Hz or 400 V-III-50 Hz power supply. Available in 60 Hz. Others voltages by request.
- ▶ Minimal R-134a or R-449A refrigerant load.
- ▶ Hermetic reciprocating compressor.
- ▶ High and low pressure switches.
- ▶ Oversized double air flow evaporating unit designed for relative humidity control between 60 % and 95 %*.
- ▶ Built-in solenoid and thermostatic expansion valves (evaporating unit).
- ▶ Air defrost.
- ▶ Stainless steel drain pan.
- ▶ Flare-type connections (up to 1/2"-3/4") with service valves.
- ▶ MCB protection.
- ▶ Liquid receiver.
- ▶ Refrigerant pre-load for 10 m piping.
- ▶ Multifunction electronic control with temperature and humidity control and remote keyboard.

Series

- ▶ **HSF-D:** Split systems with low-noise condensing unit and high humidity double-flow evaporating unit.
- ▶ **HSH-CD:** Split systems with centrifugal condensing unit and high humidity double-flow evaporating unit.

Installation scheme

Maximum vertical distance between units of 15 m if the condensing unit is placed at a higher level than the evaporating unit, and 6 m otherwise.

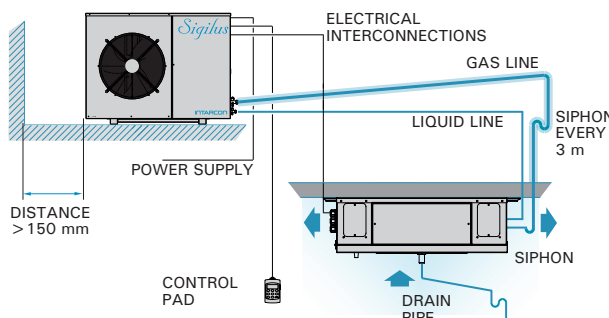

- ❄ **Low-profile double-flow evaporating unit, oversized for high relative humidity applications.**
- ❄ **Passive humidity control (humidity regulation between 60 and 95 %).***
- ❄ **Factory-tested systems with no need for on-site tests.**
- ❄ **Refrigerant pre-load.**
- ❄ **Units exempt from leak checks.**

Conservation at controlled relative humidity

The preservation of certain products, such as fruits, vegetables or cut flowers, requires control of the relative humidity in the cold room within a certain range.

These unit adjusted for high relative humidity are especially suitable for fruit and vegetable products preservation cold room.

The evaporators have a double air discharge through oversized coils to obtain up to a high level of relative humidity inside the chamber at around 95 %, avoiding loss of humidity and weight of the product.



Electronic temperature and humidity control

The unit incorporates an advanced electronic regulation for the control of the temperature and humidity inside the cold room.

- Multifunction remote digital control with temperature and relative humidity display.
- Relative humidity control in the regulation range from 60 % to 95 %*.
- Optionally, active humidification kits with steam lances and dehumidification and stove kits are integrated.

* The humidity regulation in the cold room is carried out passively, acting on the evaporator flow, without water vapour. The actual range of humidity regulation depends largely on the conditions of the cold room, absolute outside humidity and type of product.

Electrical interconnections

For the interconnection of the condenser and evaporator units, the following cable sections must be provided for a length of 10 m.

Power supply	230 V-I-50 Hz	400 V-III-50 Hz
Probes	4 x 1 mm ²	
Manoeuvre	3 x 1 mm ² + G	5 x 1 mm ² + G
Control pad	2 x 1 mm ²	

To know electrical interconnections of each model: see technical manual.

230 V-I-50 Hz / 400 V-III-50 Hz | Positive temperature - Humidity control | R-134a / R-449A

Series / Model	Compressor		Cooling capacity / Cold room volume according to cold room temperature ⁽¹⁾				Input power (kW)	Max. current (A)	Evap. air flow (m³/h)	Condens. air flow (m³/h)	Liq-Gas cooling connection	Refrig. load (kg) ⁽²⁾	Weight (kg)	SPL dB(A) ⁽³⁾	Price (€)	
	HP	Power supply	5 °C RH 95 % W	5 °C RH 95 % m³	10 °C RH 95 % W	10 °C RH 95 % m³										
R-134a	HSF-DY-12 015	1/2	230 V-I	1 544	22	1 906	38	0.74	6.5	1 800	1 700	1/4"-1/2"	< 2.0	57+32	34	3 908
	HSF-DY-12 026	3/4	230 V-I	2 116	32	2 594	53	1.06	10.2	1 800	1 700	1/4"-1/2"	< 2.0	65+32	34	4 221
	HSF-DY-13 033	1	230 V-I	2 620	43	3 192	73	1.30	11.0	3 150	1 700	1/4"-1/2"	< 2.5	67+45	34	5 193
	HSF-DY-13 053	1 1/2	230 V-I *	3 486	64	4 237	103	1.90	13.6	3 150	1 700	1/4"-5/8"	< 3.0	77+65	35	6 183
	HSF-DY-14 074	2	230 V-I *	4 977	91	6 090	148	2.57	17.7	5 700	1 700	1/4"-3/4"	< 5.0	79+65	37	7 265
	HSF-DY-24 086	4	400 V-III	6 773	134	8 311	217	2.87	14.5	5 700	3 700	3/8"-7/8"	< 6.0	96+65	38	8 195
	HSF-DY-24 108	5	400 V-III	7 865	158	9 713	263	3.40	17.5	5 700	3 700	3/8"-7/8"	< 6.0	98+65	35	8 979
	HSF-DY-24 136	6 1/2	400 V-III	9 870	202	11 960	331	4.44	21.5	5 700	3 700	3/8"-1 1/8"	< 6.5	101+70	34	11 800
R-449A	HSF-DG-1 014	1/2	230 V-I	1 801	25	2 112	41	0.85	6.6	1 100	1 700	1/4"-1/2"	< 2.0	59+32	34	3 768
	HSF-DG-1 016	5/8	230 V-I	2 015	29	2 378	47	0.93	7.5	1 100	1 700	1/4"-1/2"	< 2.0	67+32	34	4 069
	HSF-DG-1 018	3/4	230 V-I	2 582	38	3 036	62	1.22	9.1	1 800	1 700	1/4"-1/2"	< 2.0	68+45	34	4 843
	HSF-DG-1 024	1	230 V-I	2 945	46	3 478	75	1.40	11.3	1 800	1 700	3/8"-5/8"	< 3.5	82+45	34	5 172
	HSF-DG-1 026	1 1/4	230 V-I *	3 289	54	3 849	86	1.53	16.3	1 800	1 700	3/8"-5/8"	< 3.5	83+45	34	5 421
	HSF-DG-1 034	1 1/2	230 V-I *	3 734	64	4 361	100	2.09	5.9	1 800	1 700	3/8"-5/8"	< 3.5	83+45	35	5 842
	HSF-DG-1 038	1 3/4	400 V-III	4 905	85	5 760	135	2.02	7.8	3 150	3 200	3/8"-5/8"	< 4.0	82+65	29	6 779
	HSF-DG-2 048	2	400 V-III	6 170	115	7 244	175	2.53	7.9	3 150	3 700	3/8"-3/4"	< 5.0	84+65	26	7 208
	HSF-DG-2 054	2 1/2	400 V-III	6 852	130	7 997	200	2.77	9.8	3 150	3 700	3/8"-3/4"	< 5.0	85+65	26	7 465
	HSF-DG-2 060	3	400 V-III	7 844	150	9 122	230	3.28	11.3	3 800	3 700	3/8"-3/4"	< 5.0	88+65	26	8 178
	HSF-DG-2 068	3 1/2	400 V-III	8 576	165	9 934	260	3.77	12.3	3 800	3 700	1/2"-3/4"	< 5.0	88+65	25	9 134
	HSF-DG-3 086	4	400 V-III	10 308	200	12 124	320	4.74	14.5	5 700	4 000	1/2"-7/8"	< 9.0	115+70	38	10 746

Options

- ▶ Change to 400 V-III-50 Hz power supply. + 5 %
- ▶ Proportional control of condensing pressure through fan speed variation (already included in 2/22 series and above). + 262 €
- ▶ Coil protection grille. + 95 €
- ▶ Built-in active humidification kit. By request
- ▶ Dehumidification and heating kit. By request
- ▶ Built-in oil separator. + 617 €
- ▶ Anti-corrosion evaporator coil coating. + 6 %
- ▶ Anti-corrosion condenser coil coating. + 4 %

Dimensions

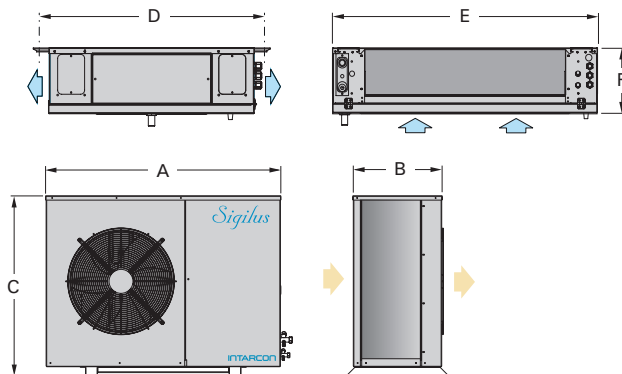

Dimensions (mm)		A	B	C	D	E	F	Evap. fan
R-134a	12 series	1 030	375	580	798	1 056	245	2x Ø 360
	13 series	1 030	375	580	798	1 756	245	3x Ø 360
	14 series	1 030	375	580	888	2 156	295	3x Ø 450
	24 series	1 080	415	830	888	2 156	295	3x Ø 450
R-449A	HSF-DG-1 014 and 1 016	1 030	375	580	798	706	245	1x Ø 360
	HSF-DG-1 018 up to 1 034	1 030	375	580	798	1 056	245	2x Ø 360
	HSF-DG-1 038	1 030	375	580	798	1 756	245	3x Ø 360
	HSF-DG-2 048 up to 2 068	1 080	415	830	798	1 756	245	3x Ø 360
	HSF-DG-3 086	1 150	480	1 100	888	2 156	295	3x Ø 450

⁽¹⁾ Nominal performances refer to operation with cold room temperatures of 5 °C, with a relative humidity cold room of 95 %, and ambient temperature of 35 °C. Estimated cold room volume according to conditions of the calculation bases (page 8).

⁽²⁾ Units with refrigerant load less than 5 tons of CO₂ equivalent (3.5 kg of R-134a or R-449A) exempt from leak checking, Regulation (EU) No 517/2014.

⁽³⁾ Sound pressure in dB (A) in open field at 10 m from the unit.

* Available units with 400 V-III-50 Hz power supply.

Centrifugal version (HSH-CD series)

High humidity split systems are also available with centrifugal condensing units.

Series / Model	HP	Cooling capacity		Price (€)	
		5 °C RH 95 % W	5 °C RH 95 % m³		
R-134a	HSH-CDY-12 015	1/2	1 415	21	3 727
	HSH-CDY-12 026	3/4	1 859	28	4 281
	HSH-CDY-12 033	1	2 242	32	4 702
	HSH-CDY-23 033	1	2 746	45	5 010
	HSH-CDY-23 053	1 1/2	3 507	64	5 517
	HSH-CDY-23 074	2	4 526	82	6 859
	HSH-CDY-34 074	2	5 140	93	7 212
	HSH-CDY-44 086	4	6 741	134	8 187
R-449A	HSH-CDY-44 108	5	7 817	158	8 911
	HSH-CDY-44 136	6 1/2	9 791	200	11 049
	HSH-CDG-1 014	1/2	1 399	20	3 595
	HSH-CDG-1 016	5/8	1 608	22	3 724
	HSH-CDG-2 018	3/4	2 510	38	4 536
	HSH-CDG-2 024	1	2 902	46	4 832
	HSH-CDG-2 026	1 1/4	3 242	54	5 025
	HSH-CDG-3 034	1 1/2	4 056	71	5 487
	HSH-CDG-3 038	1 3/4	4 360	77	6 401
	HSH-CDG-3 048	2	6 160	116	7 061
HSH-CDG-4 054	2 1/4	6 833	132	7 457	
HSH-CDG-4 060	3	7 652	149	8 116	
HSH-CDG-4 068	3 1/2	8 371	164	8 711	

Condensing units features as in pages 21 up to 22.

Wine cellar



Wine cellar refrigeration split systems with low-noise axial or centrifugal condensing unit and double-flow evaporating unit with heating function, humidification / dehumidification system and condensed water pump, and compact ceiling construction with axial or centrifugal condensation.

Applications

- ▶ Bottled wine preservation.
- ▶ Cigar and tobacco preservation.
- ▶ Refrigeration at high temperature with humidity control.
- ▶ Preservation of wine in barrels.
- ▶ Cheese curing.
- ▶ Mini drying rooms.

Series

- ▶ **VSF-G:** Wine cellar split systems with low-noise condensing unit.
- ▶ **VSH-CG:** Wine cellar split systems with centrifugal condensing unit.
- ▶ **VCR-N:** Wine cellar roof-top monoblock with axial fan.
- ▶ **VCR-C:** Wine cellar roof-top monoblock with centrifugal fan.

Split systems installation scheme

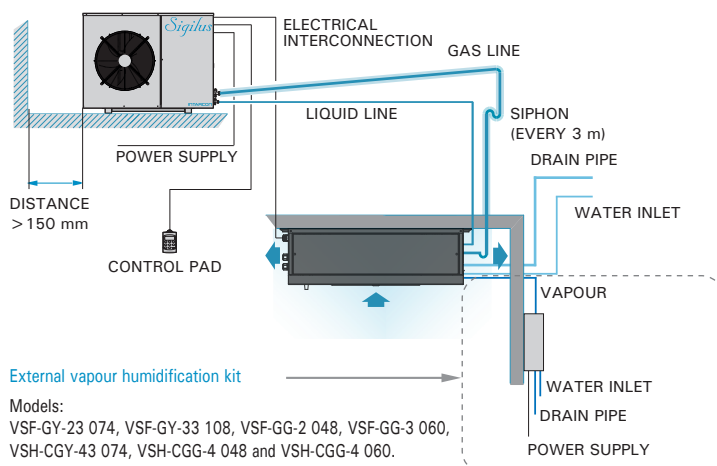

External vapour humidification kit

Models:
VSF-GY-23 074, VSF-GY-33 108, VSF-GG-2 048, VSF-GG-3 060,
VSH-CGY-43 074, VSH-CGG-4 048 and VSH-CGG-4 060.

Maximum vertical distance between units of 15 m if the condensing unit is placed at a higher level than the evaporating unit, and 6 m otherwise.

- ❄ Specifically designed for wine preservation in cellars.
- ❄ Active humidity control.
- ❄ Active heating system.
- ❄ Factory-tested systems with no need for on-site tests.
- ❄ Refrigerant pre-load.
- ❄ Units exempt from leak checks.

Conservation of bottled wine

Bottled wine requires temperature and humidity controlled conditions that optimally conserve the product while avoiding both cork drying and label mouldiness.

The wine treatment unit guarantees optimal conditions for the preservation of bottled wine.



Wine conservation in barrel

In the conservation of wine in barrels, the relative humidity inside the cellar is of great importance, which must be adjusted so that there is no transfer of water vapour between the environment of the cellar and the interior of the barrel, avoiding thus wine wastage or water absorption by the content.

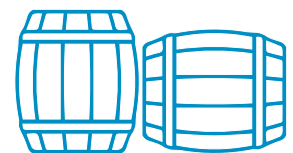

External vapour humidification kit

Vapour humidification with 3 kg/h capacity, consisting of: vapour lances integrated in the evaporator unit, a submerged electrode generating cylinder with feed valves and water purge valves.



Electrical interconnection

For the interconnection of the condenser and evaporator units, the following cable sections must be provided for a length of 10 m (except series 43 and 44).

Power supply	230 V-I-50 Hz	400 V-III-50 Hz
Probes	4 x 1 mm ²	
Manoeuvre	10 x 1 mm ²	
Heating resistance	2 x 2.5 mm ² + G	4 x 1.5 mm ² + G
Control pad	2 x 1 mm ²	
Humidifier	2 x 1 mm ²	

To know electrical interconnections of each model: see technical manual.

VSF-G / VSH-CG series

Features

- ▶ 230 V-I-50 Hz or 400 V-III-50 Hz power supply. Available in 60 Hz. Others voltages by request.
- ▶ Minimal R-134a or R-449A refrigerant load.
- ▶ Hermetic reciprocating compressor.
- ▶ Double-flow low-profile evaporating unit with heaters and active humidification / dehumidification system; and evaporation anti-corrosion coated coil.
- ▶ Air defrost; Air filter.
- ▶ Built-in solenoid and thermostatic expansion valves.
- ▶ Stainless steel drain pan and condensed water pump.
- ▶ Flare-type cooling connections (up to 1/2"-3/4) and service valves.
- ▶ Liquid receiver and refrigerant pre-load for 10 m piping.
- ▶ Proportional condensation control (VSF 1/2/3 and VSH 4/43 series) and all / nothing condensation control (VSF 0, VSH 2/22 and 3/33 series).
- ▶ Multifunction electronic dual control of temperature and humidity with remote keyboard and digital regulation of condensing temperature.
- ▶ MCB protection.



VSF-G series



VSH-CG series

230 V-I-50 Hz / 400 V-III-50 Hz | Positive temperature - Wine cellar | R-134a / R-449A

Series / Model	Compressor		Cellar volume (m ³)		Cooling capacity at 15 °C 70 % RH (W) ⁽¹⁾	Heating capacity (W)	Input power (kW) ⁽²⁾	Input power (kW) ⁽³⁾	Max. current (A)	Evap. air flow (m ³ /h)	Conden. air flow (m ³ /h)	Liq-Gas cooling connection	Refrigerant charge (kg) ⁽⁴⁾	Weight (kg)	SPL dB(A) ⁽⁵⁾	Price (€)	
	HP	Power supply	Without insulation	Insulation													
R-134a	VSF-GY-00 010	3/8	230 V-I	11	37	1 242	1 000	1.52	0.52	8.8	500	350	1/4"-3/8"	< 1.5	46+30	28	5 392
	VSF-GY-10 015	1/2	230 V-I	20	53	1 820	1 000	1.67	0.67	10.1	500	1 700	1/4"-1/2"	< 2.0	57+30	34	6 145
	VSF-GY-11 033	1	230 V-I	47	100	3 281	1 500	2.76	1.26	16.3	1 100	1 700	1/4"-5/8"	< 2.5	67+42	34	7 397
	VSF-GY-12 053	1 1/2	230 V-I *	74	168	4 683	3 000	4.93	1.93	26.1	1 800	3 200	3/8"-3/4"	< 3.5	77+52	35	9 160
	VSF-GY-23 074 ⁽⁶⁾	2	230 V-I *	149	297	7 497	6 000	8.60	2.60	43.7	3 150	3 700	3/8"-3/4"	< 5.5	79+75	34	12 081
R-449A	VSF-GY-33 108 ⁽⁶⁾	5	400 V-III	224	444	9 944	6 000	9.50	3.50	26.1	3 150	4 000	3/8"-7/8"	< 6.0	98+75	35	14 147
	VSF-GG-0 008	1/3	230 V-I	10	35	1 227	1 000	1.16	0.48	8.4	500	350	1/4"-3/8"	< 1.5	48+30	28	5 082
	VSF-GG-1 014	1/2	230 V-I	24	60	2 134	1 500	2.55	1.05	13.5	1 100	1 700	1/4"-1/2"	< 2.5	59+42	34	5 790
	VSF-GG-1 024	1	230 V-I	47	100	3 388	3 000	4.81	1.81	24.9	1 800	1 700	3/8"-5/8"	< 4.0	82+52	34	6 971
	VSF-GG-1 034	1 1/2	230 V-I *	75	170	4 944	3 000	5.55	2.55	29.9	1 800	3 200	3/8"-5/8"	< 4.0	83+52	35	8 153
VSF-GG-2 048 ⁽⁶⁾	2	400 V-III	151	300	7 830	6 000	9.19	3.19	17.9	3 150	3 700	1/2"-3/4"	< 5.5	84+75	26	11 017	
VSF-GG-3 060 ⁽⁶⁾	3	400 V-III	221	450	10 490	6 000	10.87	4.87	19.5	5 200	6 500	1/2"-7/8"	< 6.5	88+75	26	12 590	

Options

- ▶ Change to 400 V-III-50 Hz power supply. + 5 %
- ▶ Proportional control of condensing pressure through fan speed variation (already included in VSF 1/2/3 series and VSH 4/43 series). + 262 €
- ▶ Built-in oil separator. + 617 €
- ▶ Condenser coil polyurethane anti-corrosion treatment. + 4 %
- ▶ Coil protection grille. + 95 €

Dimensions

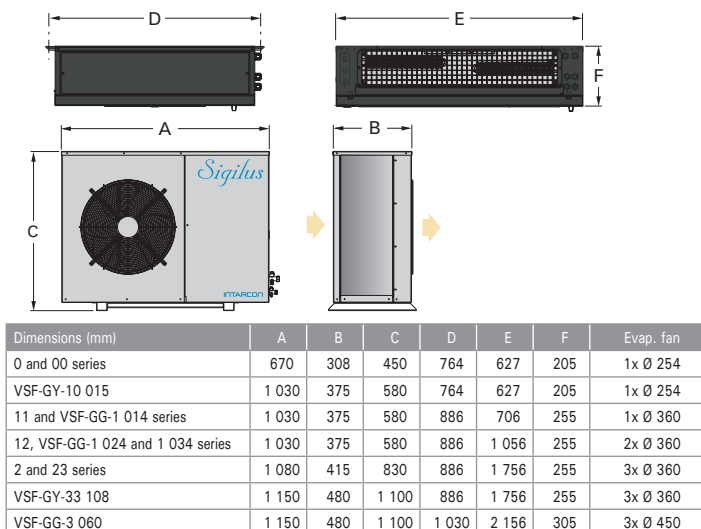

⁽¹⁾ Nominal performances refer to operation with cold room temperatures of 15 °C (PT) with relative humidity cold room of 70 % and ambient temperature of 35 °C. Volume of cold room for the hotel industry estimated without insulation and warehouse volume estimated with 30 mm insulation. Others applications by request

⁽²⁾ Input power at dehumidification mode.

⁽³⁾ Input power at refrigeration mode.

⁽⁴⁾ Units with refrigerant load less than 5 tons of CO₂ equivalent (3.5 kg of R-134a or R-449A) exempt from leak checking, Regulation (EU) No 517/2014.

⁽⁵⁾ Sound pressure in dB (A) in open field at 10 m from the unit.

* Available units with 400 V-III-50 Hz power supply.

⁽⁶⁾ Standard models with external vapour humidification kit.

Centrifugal version (VSH-CG series)

Wine cellar split systems are also available with centrifugal condensing unit.

Series / Model	HP	Conden. air flow (mmca) (m ³ /h)	ASP (6)	Price (€)	
R-134a	VSH-CGY-10 010	3/8	575	8	4 915
	VSH-CGY-21 015	1/2	1 000	12	6 145
	VSH-CGY-22 033	1	1 000	12	7 397
	VSH-CGY-33 053	1 1/2	1 500	14	9 160
	VSH-CGY-43 074 ⁽⁶⁾	2	3 500	10	12 081
R-449A	VSH-CGG-2 014	1/2	1 000	12	5 790
	VSH-CGG-2 024	1	1 000	12	6 971
	VSH-CGG-3 034	1 1/2	1 500	14	8 153
	VSH-CGG-4 048 ⁽⁶⁾	2	3 500	10	11 017
VSH-CGG-4 060 ⁽⁶⁾	3	3 500	10	12 590	

⁽⁶⁾ Available static pressure of condensation.

Condensing units features as in pages 21 up to 22.

VCR-N / VCR-C series

Features

- ▶ R-134a refrigerant load, below 1.5 kg.
- ▶ Hermetic reciprocating compressor.
- ▶ High and low pressure switches.
- ▶ Air defrost.
- ▶ Heating elements, humidification / dehumidification system.
- ▶ Evaporation coils with anti-corrosion coating.
- ▶ Water purge system.
- ▶ Thermostatic expansion valve.
- ▶ Evaporation drawer of 50 mm sandwich panel made of polyurethane foam, internally coated with pre-lacquered steel plate.
- ▶ Multifunction electronic dual control of temperature and humidity with remote keyboard and digital regulation of condensing temperature.



VCR-N series



VCR-C series

230 V-I-50 Hz | Positive temperature | R-134a

Series / Model	Compressor		Cellar volume (m ³)		Power supply at 15 °C 70 % RH (W) ⁽¹⁾	Heating capacity (W)	Input power (kW)	Max. current (A)	Evap. air flow (m ³ /h)	Conden. air flow (m ³ /h)	Refrig. load (kg) ⁽²⁾	Weight (kg)	SPL dB(A) ⁽³⁾	Price (€)
	HP	Power supply	Without insulation	Insulated										
R-134a VCR-NY-1 010	3/8	230 V-I	15	34	1 269	1 000	1.55	8.9	600	575	< 1.0	73	29	4 706
VCR-NY-2 015	1/2	230 V-I	25	63	2 020	1 000	1.83	10.8	1 150	1 000	< 1.5	88	34	5 068
VCR-NY-2 033	1	230 V-I	42	95	3 203	2 000	3.37	19.0	1 150	1 000	< 1.5	98	34	6 093

Options

- ▶ Non-return discharge damper (VCR-C series). + 27 €
- ▶ Adaptation of air discharge to circular duct. + 105 €
- ▶ Vertical air flow (centrifugal version).

Monoblock installation scheme

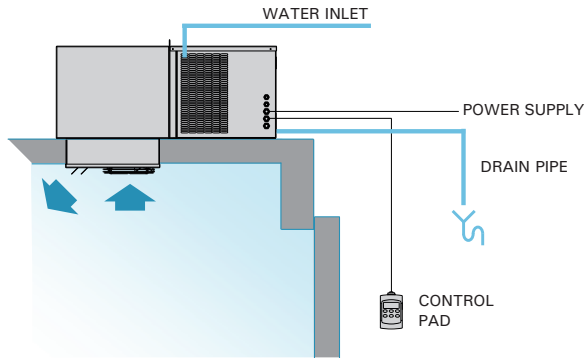

Dimensions

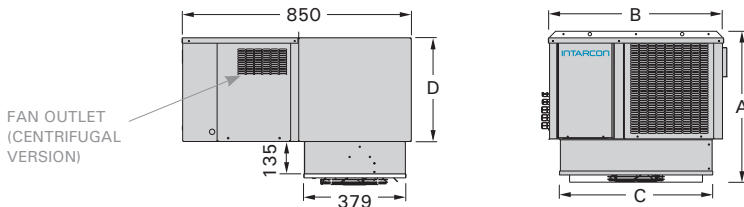

Measuring mm.

Dimensions (mm)	A	B	C	D	Fan outlet	Hopper
1 series	574	665	582	385	185 x 115	Ø 150
2 series	677	835	756	469	230 x 130	Ø 200

⁽¹⁾ Nominal performances refer to operation with cold room temperatures of 15 °C (PT) with relative humidity cold room of 70 % and ambient temperature of 35 °C.

Volume of cold room for the hotel industry estimated without insulation and warehouse volume estimated with 30 mm insulation.

⁽²⁾ Units with refrigerant load less than 5 tons of CO₂ equivalent (3.5 kg of R-134a or R-449A) exempt from leak checking, Regulation (EU) No 517/2014.

⁽³⁾ Sound pressure in dB (A) in open field at 10 m from the unit.

Centrifugal version (VCR-C series)

Wine cellar split systems are also available with centrifugal condensation unit.

Series / Model	HP	Conden. air flow (m ³ /h)	ASP (mmca) ⁽⁴⁾	Price (€)
R-134a VCR-CY-1 010	3/8	575	8	4 945
VCR-CY-2 015	1/2	1 000	8	5 429
VCR-CY-2 033	1	1 000	12	6 634

⁽⁴⁾ Available static pressure of condensation.

Exhaust duct

Recommended size for 20 m long steel, PVC or fibreglass ducts (each elbow at 90° equals 5 m in length). For flexible or semi-flexible ducts use a larger size.

- 1 series: 200 x 200 mm or Ø 150 mm
- 2 series: 250 x 150 mm or Ø 200 mm

Mounting frame

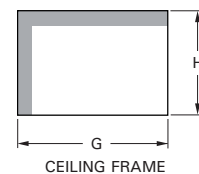

Dimensions (mm)	G	H
1 series	588	385
2 series	762	385



intarSANIT

STERILIZATION | PURIFICATION | VENTILATION



COVID-19
free



Safety
and health



Smart
solution

intarSANIT | new air conditioning and supply



intarSANIT-TCH is the new air conditioning and supply solution for work rooms, with heat recovery from extract air.

The ventilation unit is specifically designed for the supply of fresh air in work rooms and food processing rooms, which operate at a temperature of 10 to 15 °C.

Features

- ▶ 230 V-I-50 Hz power supply. Available in 60 Hz. Others voltages by request.
- ▶ Built-in a white coated aluminium frame.
- ▶ Compact and lightweight design.
- ▶ Adjustable ventilation flow from 500 up to 1 000 m³/h.
- ▶ Compact refrigeration system with natural refrigerant R-290.
- ▶ Static and dynamic heat recovery from exhaust air.
- ▶ Air supply and extraction by centrifugal fan for connection to duct or textile diffuse.
- ▶ G4 pre-filter and F7 new air filter.

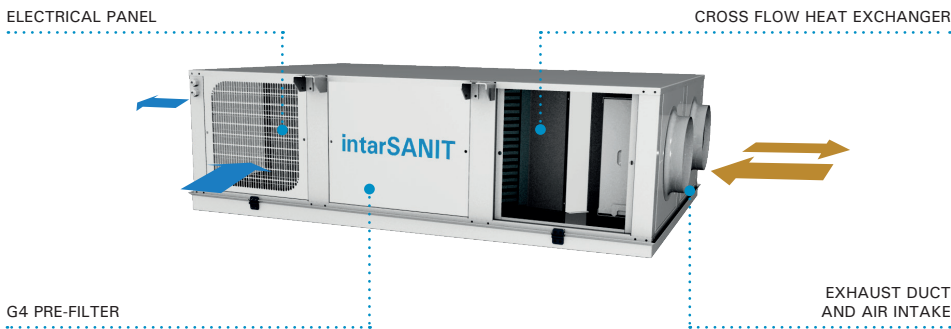

- ❄ Air cold room filtration, sterilization and purification.
- ❄ Ventilation flow adaptable to occupation, and room overpressure.
- ❄ High energy efficiency with heat recovery from exhaust air.
- ❄ Easy ceiling installation.

Installation scheme

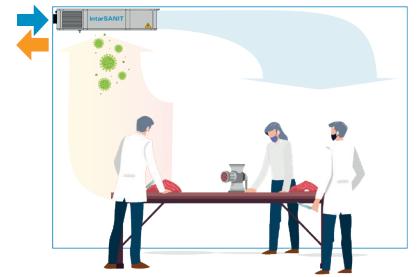

Ventilation of process rooms

The regulations on safety and health at work stipulate a minimum ventilation flow of 50 m³/h per worker for non-sedentary work (Directive 89/391/EEC).

UNE-EN 16798 establishes the requirements for air quality. In work rooms, at least medium air quality (IDA3) should be ensured, and high air quality (IDA1) for laboratories and clean rooms.

Cold room type	Indoor air quality UNE-EN 13779	Metabolic activity of the worker at 12°C	Level of CO ₂ in the air above the outer level ppm	Ventilation flow / person (m ³ /h)*
Laboratories, clean rooms	IDA 1, high quality	Light work seated 1.5 met	350	80
Workshops, handling rooms	IDA 2, good quality	Light work standing 2 met	500	75
Cutting rooms	IDA 3, medium quality	Moderate work 1.5 met	800	60
Warehouses, packing rooms, loading and unloading	IDA 4, low quality	Moderate work 1.5 met	1 200	50

Table 1.* Estimated ventilation flow for rooms where contamination is due solely to worker respiration, with good air mixing by dilution.

230 V-I-50 Hz | Ventilation | R-290

Series / Model	Recovered power (W)	Cooling capacity (W)	Total cooling power (W)*	Ventilation air flow (m ³ /h)	Available impulsion static pressure (Pa)	Impulsion temperature	Max. current (A)	Input power (kW)	Weight (kg)	SPL (dBA) from 3 m	Price (€)
R-290 TCH-1	4 700	4 800	9 500	1 000	50	15.0	16	2,37	110	49	6 061
				750	80	13.5					
				500	100	12.0					

Options

- ▶ CO₂ and VOCs level control.

* Nominal performance for outdoor ambient conditions of 35 °C 40 % RH and indoor conditions of 12 °C.

intarSANIT | air sterilization and purification



- ❄️ Air cold room filtration, sterilization and purification.
- ❄️ Double sterilizing effect: UV-C radiation and HEPA filtration.
- ❄️ Easy ceiling installation.
- ❄️ Sterilization system integrated in double flow evaporator unit.

intarSANIT-TPD is the solution for the sterilization and purification of the air in food handling rooms, industrial kitchens, clean rooms and other establishments.

Ultraviolet irradiation renders the DNA of micro-organisms useless, preventing their reproduction. HEPA filtration with 99.995 % efficiency in 300 nm particles.

Features

- ▶ 230 V-I-50 Hz power supply. Available in 60 Hz. Others voltages by request.
- ▶ Built-in a white coated aluminium frame.
- ▶ Compact and lightweight design.
- ▶ G4 pre-filter.
- ▶ UV-C germicidal irradiation.
- ▶ HEPA filters.
- ▶ Radial variable speed EC fan.

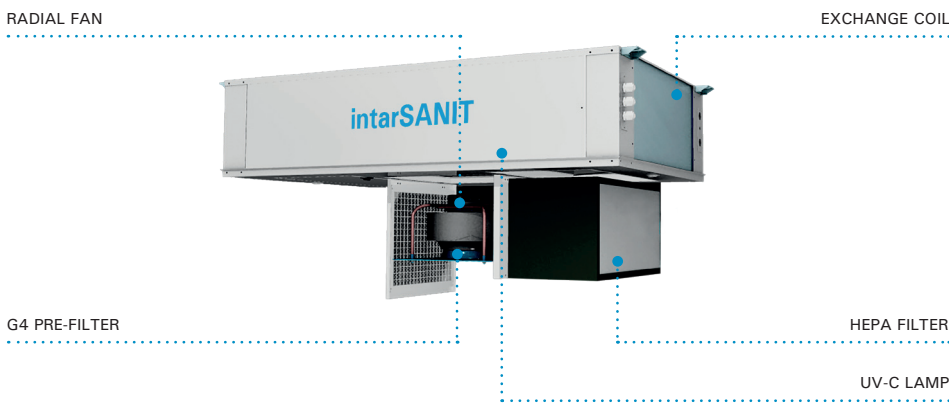

Installation scheme

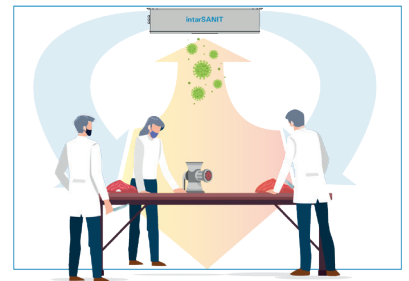

HEPA filtration

The HEPA filters have a retention efficiency of 300 nm particles of 99.995 %. That is, for every 100 000 particles of 0.3 microns in diameter, only 5. As shown in figure 2, the droplet size (1 micron) is greater than the MPPS (300 nm), which allows to conclude that the HEPA filter is effective at retaining aerosols.

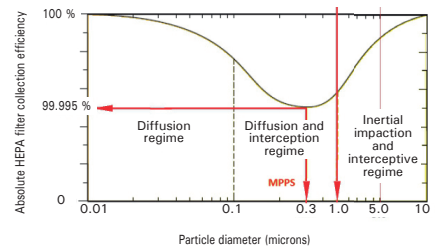

Fig. 1. Filtration efficiency of a HEPA filter. The UNE EN 1822 standard defines the filtration efficiency of a HEPA filter as the filtration performance of the particle with the highest penetration MPPS (Maximum Penetration Particle size). Particles around 0.3 μm are the most difficult for an absolute HEPA filter to trap and are what dictate the efficiency of the filter. The smallest nano-particles are easier to trap through the diffusion phenomenon, the larger ones through the impact, inertial and interception mechanisms.

230 V-I-50 Hz | Purification | R-290

Series / Model	Flow (m³/h)		Recommended room volume (m³)	Cooling capacity (kW) (optional) SC1: 10 °C 85 % RH DT1 = 10 K		Coil (optional)			Fan		Max. current (A)	Input power	Range (m)	Weight (kg)	SPL (dBA) from 3 m	Price (€)
	Min	Max.		V. Min.	V. Max.	Fin spacing (mm)	Surf. (m²)	Vol. (L)	Type	Ø mm						
R-290 TPD-3	1 500	3 000	100 - 200	4.0	6.0	5.0	13	5.8	Radial EC	1x Ø 280	2.9	0.7	6	95	49	7 221
TPD-6	3 000	6 000	200 - 400	8.0	12.0	5.0	26	7.6	Radial EC	2x Ø 280	5.8	1.3	6	180	52	13 376

Options

- ▶ Carbon filter.
- ▶ Cooling coil.

* Nominal performance for outdoor ambient conditions of 35 °C 40 % RH and indoor conditions of 12 °C.

Dimensions

TCH series

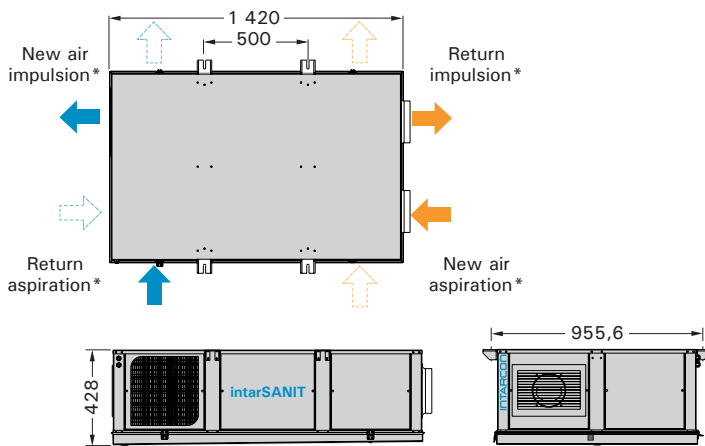

* Interchangeable air connection sides.

TPD series

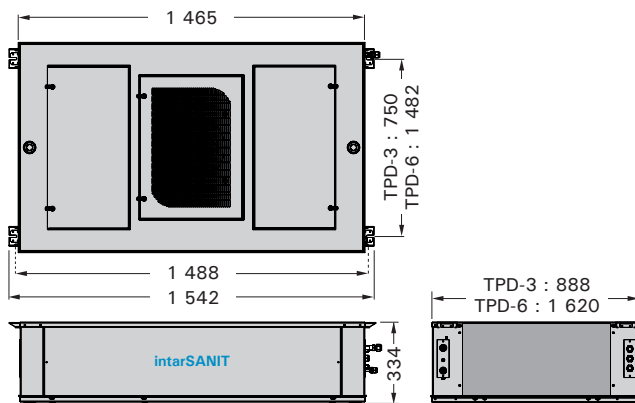

Measuring mm.

Control

iPro electronic control with distance digital display.

- ▶ Air supply temperature control.
- ▶ Room temperature control.
- ▶ Control option: remote touch display.
- ▶ Serial communication (TCH).
- ▶ Filter status control (TCH).
- ▶ Air flow control (TPD).
- ▶ External communication (TPD).



TPD / TCH series

Air pathogens transmission

When talking, coughing or sneezing, small droplets are emitted that evaporate quickly and give rise to aerosols of very small particles. These micro-particles can remain in the air for hours and be transported long distances. It has been shown that the survival of viruses and bacteria in these particles is greater the lower the air temperature. The transmission of pathogens by air in closed places is favoured by the recirculation of air without sterilization or filtration treatment and the absence of ventilation with outside air, and it has been shown that these aerosols are the main contagion route of COVID-19.

The simulation of the transmission of aerosols in a process room shows that the probability of contagion in a room without ventilation is 15 times higher than a room equipped with a minimum renewal of outside air and an adequate level of filtration.

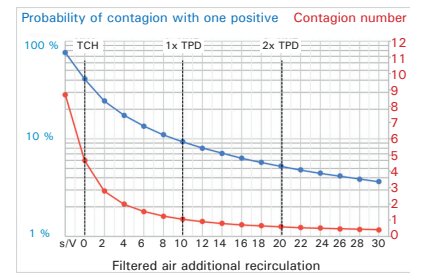

Fig. 2. Simulation of the probability of contagion given a positive in a 200 m² work room with 13 workers at a temperature of 12 °C. Source: Prof. José L. Jiménez, Dept. of Chem. And CIRES, Univ. of Colorado-Boulder.

Ultraviolet light sterilization

Ultraviolet UV-C radiation of wavelengths of 280 nm - 200 nm damages the DNA of many micro-organisms and prevents them from reproducing. In this way, bacteria, viruses and fungi can be eliminated without leaving residues. The ultraviolet light is placed in the ventilation section to concentrate its biocidal action on the HEPA filters, the G4 pre-filter and the access doors, keeping the interior air treatment section sterile; This guarantees the best hygiene during filter replacement and unit cleaning.



Fig 3. intarSANIT complies with UNE 0048/20 June 2020, on the protection of the health and safety of workers against the risks related to exposure to artificial optical radiation.



Waterloop system

Indirect condensation system



Complies with
Ecodesign



VRC multi-service
version



Low noise
construction

Waterloop system

Waterloop is a commercial refrigeration system, consisting of: DX cooling units distributed, with indirect condensation by a water circuit; and one or more units in parallel air-cooler connected to the condensation heat dissipation.

Supermarkets and food stores applications

Waterloop system allows distributed cooling production at different temperatures, with a single condensing water loop. Condensation heat recovery from the cooling units can easily be carried out in air conditioners or fan coils.

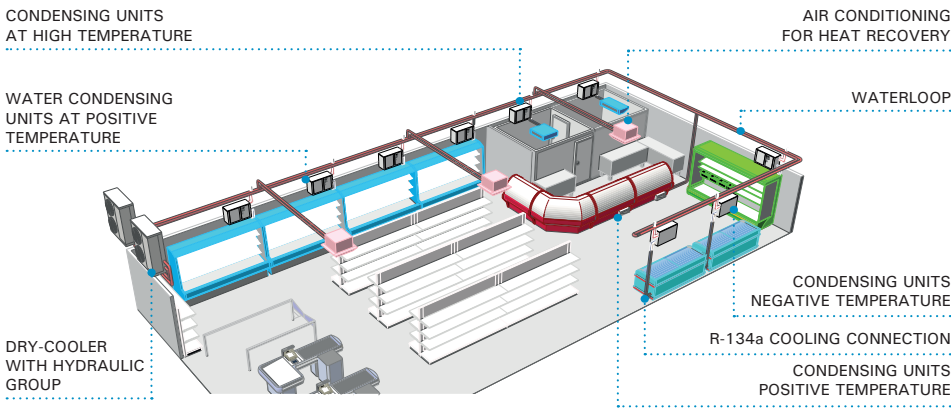

Application in industrial kitchens

Waterloop system makes possible to centralise a set of cold rooms and process rooms. The use of compact R-290 waterloop units in cold rooms and process rooms is a 100 % ecological solution free of greenhouse gases.

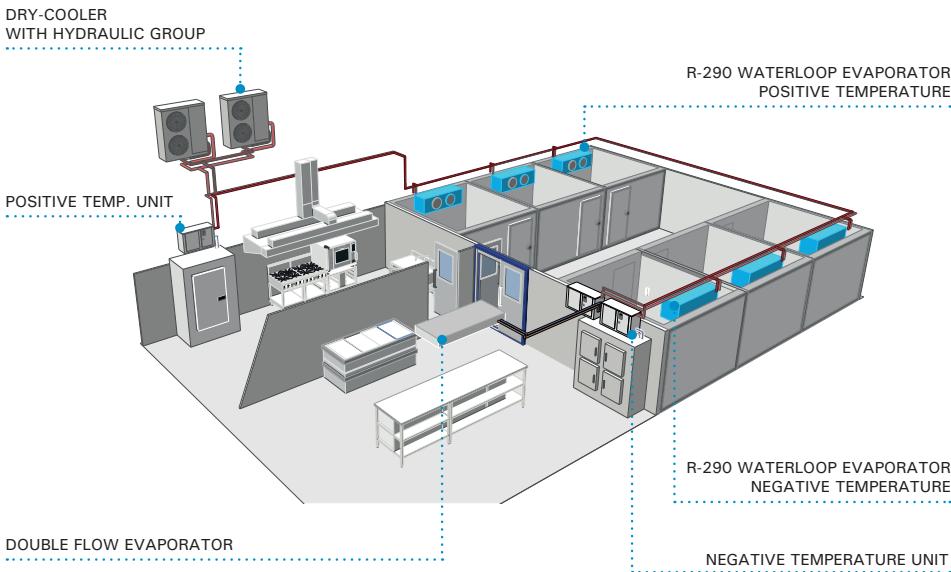

Ecology

Distributed cooling production allows to reduce and fractionate the load of HFC refrigerant in the installation, so that the risk of leakage is reduced.



Safety

Decentralization of the cooling production contributes a greater operation security of the installation, that guarantees a high availability of the system when faced with the isolated failure of a single unit.

The installation of a double air-cooler or dry-cooler in parallel, provides a greater operational security.

The condensation water loop contains only closed-circuit water working at low hydraulic pressure.



Simple installation

Waterloop system is very easy to install, thanks to its condensed water units pre-charged with refrigerant, and air-coolers or dry-coolers with inbuilt hydraulic unit/circuit.



Precision

Distributed cooling production allows adaptation of working temperatures to the needs of each service, thus obtaining an adequate degree of humidity for the best preservation of each product, and optimizing the performance of the systems.



Energy saving

Condensing units incorporate high-efficiency scroll compressors with R-134a or R-449A refrigerant for positive temperature, and R-449A for negative temperature.

Air-coolers or dry-coolers incorporate hydraulic group with electronic pump of variable flow, that adapts its functioning speed to the demand of the installation. Motor fans are equipped with speed regulators to reduce their consumption in low ambient temperatures or low load.



Versatility

Waterloop system is applicable both in new installations and in existing centralized direct expansion facilities, where the update of refrigeration plant is desired. In fact, existing refrigerating displays are usable and easily converted to new refrigerants.



Easy and flexible installation

Refrigeration units are supplied with service valves and factory refrigerant pre-load with service keys.

The waterloop can be made with polypropylene pipe without insulation, with service valves in each refrigeration unit, thus providing great flexibility in modifying the installation.



Tropicalised design

Unlike other systems on the market, the waterloop system is designed to work properly even with extreme ambient temperatures of up to 45 °C, with condensation water temperatures of up to 55 °C, and without the need to incorporate additional cooling equipment.

Waterloop system allows different configurations from a simple cold room up to a set of rooms and other refrigeration services at different temperatures.

Simple installation example 1 + 1

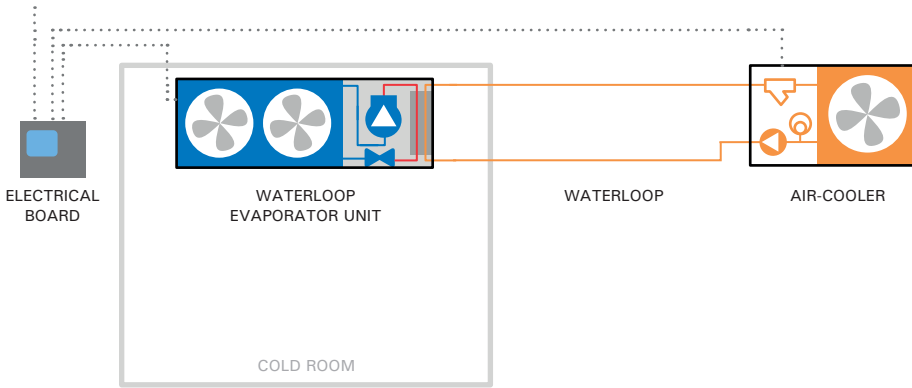

Twin installation example

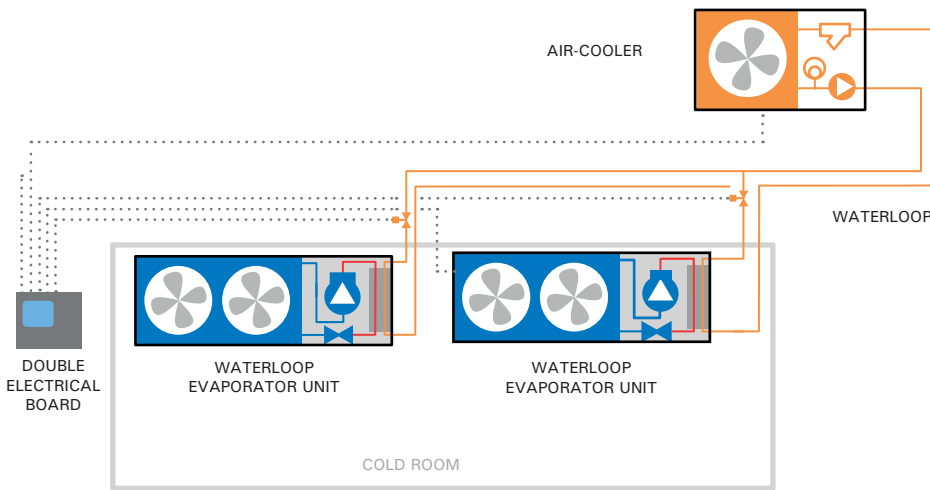

Multi installation example

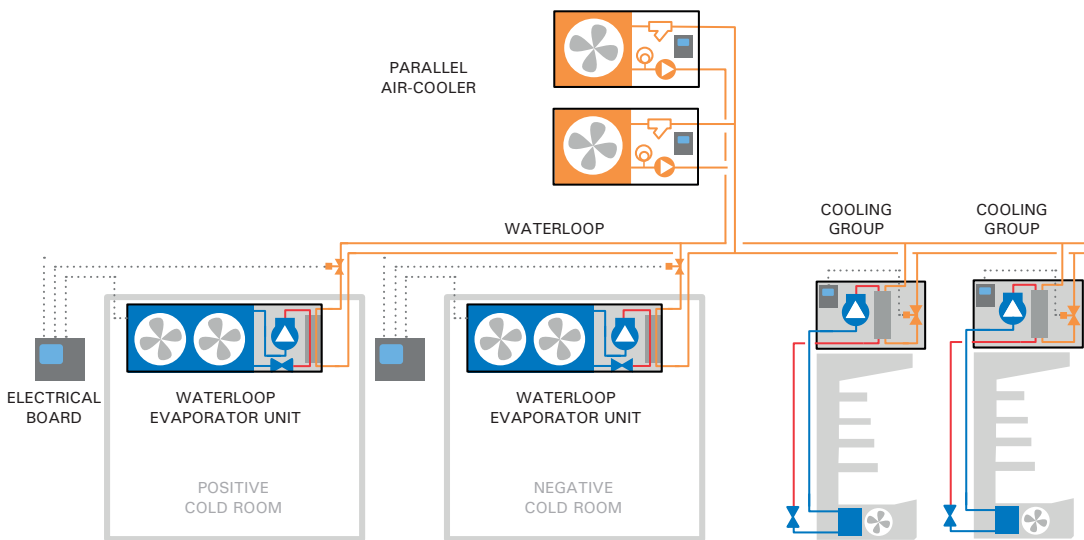

Product range

Evaporator units with built-in compressor, condensed by water, and with external panel. Designed for positive or negative cold rooms temperature.



Refrigeration units condensed by water, with external panel. Designed to service refrigerated cabinets and displays.



Aero condensers with built-in hydraulic unit, at constant or variable flow, with water loop temperature control.



Waterloop evaporating units



- ❄️ Compact unit condensed by water.
- ❄️ Minimal R-290 refrigerant charge.
- ❄️ Easy and safe installation with connection to the condensation water circuit.

Waterloop evaporator units with compressor are compact units for installation inside small cold rooms, designed with natural refrigerant R-290 and waterloop condensed.

Features

- ▶ 230 V-I-50 Hz or 400 V-III-50 Hz power supply. Available in 60 Hz. Others voltages by request.
- ▶ R-290 refrigerant charge low than 0.15 kg.
- ▶ Bodywork in aluminium sheet and structure in galvanised steel lacquered in polyester paint.
- ▶ Hermetic compressor integrated in thermally insulated compartment, with crankcase heater.
- ▶ Refrigeration circuit in annealed copper tube, with high pressure switch, filter drier and load valve.
- ▶ Evaporation coil in copper pipes and aluminium fins, thermostatic expansion valve and hot gas defrost.
- ▶ EC motor fans.
- ▶ Brazed plates heat exchanger.
- ▶ Threaded hydraulic connections.
- ▶ Control panel in white lacquered sheet metal cabinet, with MCB protection and multifunction electronic regulation.
- ▶ 3 m interconnection cable.

Installation

Installation of a closed loop water evaporator unit with an air cooler and general electrical panel:

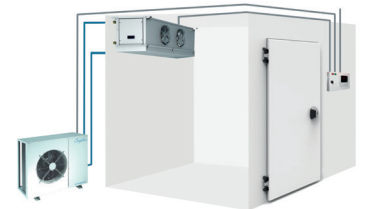

Compact R-290 system

The waterloop evaporator units are hermetically sealed compact systems with a minimum charge of R-290, exempt from the application EN 378.

They have a minimum R-290 refrigerant charge lower than the practical limit of the refrigerated volume.

Electrical board

Electrical power and control board for outside installation.

- MCB protection of compressor and manoeuvre.
- Electronic control with temperature control and recording of maximum and minimum temperatures.
- Jet Cool function.
- Energy saving function.
- Optional air condenser management with water loop temperature control and frost protection.

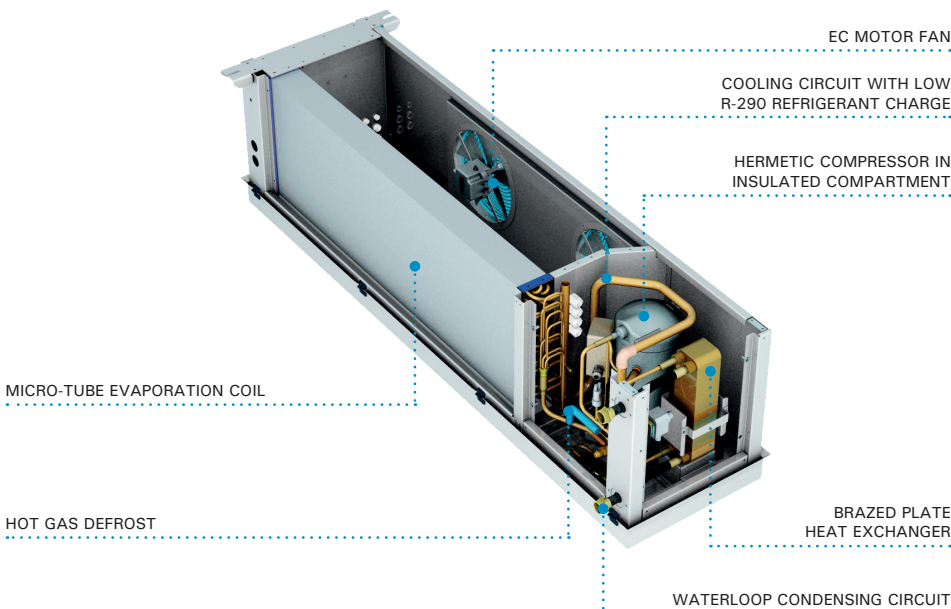

230 V-I-50 Hz / 400 V-III-50 Hz | Positive temperature | Hermetic compressor - Scroll compressor | R-290

Series / Model	Compressor		Cooling capacity / cold room volume (W) ⁽¹⁾		Input power (kW)	Max. current (A)	Evap. air flow (m ³ /h)	Conden. water flow (l/h)	PdC kPa ⁽²⁾	Hydraulic connection	Refrigerant charge (g) ⁽³⁾	Weight (kg)	Price (€)	Dry-cooler model ⁽⁴⁾	Set price (€)		
	HP	Power supply	0 °C														
			W	m ³													
R-290	1x H	MCC-ND-1 017	3/4	230 V-I	1 400	12	0,8	4,9	1 600	350	3	3/4"	210	50	2 070	CFW-0	3 732
		MCC-ND-1 034	1 1/2	230 V-I	2 230	24	1,4	9,3	1 600	600	3	3/4"	170	59	2 409	CFW-0	5 388
	1x Sc	MCC-SD-1 012	1 1/2	400 V-III	2 830	33	1,4	4,8	1 600	750	3	3/4"	265	62	3 726	CFW-1	6 538
		MCC-SD-2 017	2	400 V-III	3 850	51	2,0	5,9	1 700	1 000	5	1"	240	72	4 353	CFW-2	8 190

230 V-I-50 Hz / 400 V-III-50 Hz | Negative temperature | Hermetic compressor - Scroll compressor | R-290

Series / Model	Compressor		Cooling capacity / cold room volume (W) ⁽¹⁾		Input power (kW)	Max. current (A)	Evap. air flow (m ³ /h)	Conden. water flow (l/h)	PdC kPa ⁽²⁾	Hydraulic connection	Refrigerant charge (g) ⁽³⁾	Weight (kg)	Price (€)	Dry-cooler model ⁽⁴⁾	Set price (€)		
	HP	Power supply	-20 °C														
			W	m ³													
R-290	1x H	BCC-ND-1 034	1	230 V-I	970	9	1,0	8,8	1 600	350	3	3/4"	150	59	2 409	CFW-0	4 071
	1x Sc	BCC-SD-1 012	1 1/2	400 V-III	1 420	15	1,4	4,3	1 700	500	3	3/4"	160	68	3 909	CFW-0	5 571
		BCC-SD-2 017	2	400 V-III	1 900	24	1,8	5,8	1 700	750	3	1"	180	72	4 353	CFW-1	7 165

Options

- ▶ Electrical board for two units in the same cold room. By request
- ▶ Water solenoid valve for multi-equipment waterloop installation. By request

Dimensions

1 series

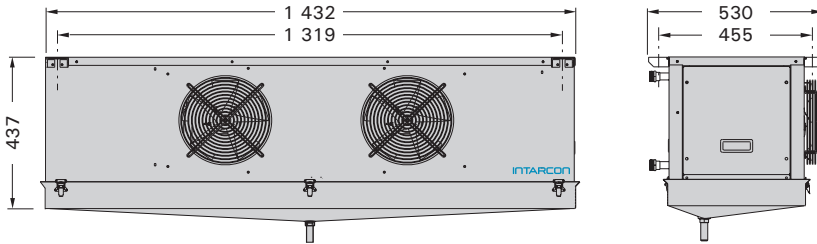

2 series

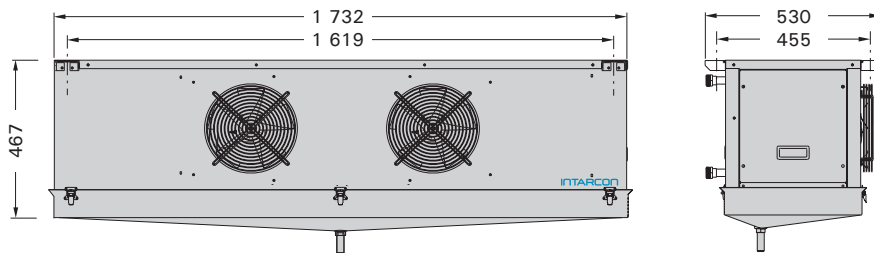

Measuring mm.

⁽¹⁾ Nominal performances refer to operation with cold room temperatures of 0 °C (PT) and -20 °C (NT) and water inlet condensation temperature of 40 °C. Estimated cold room volume according to conditions of the calculation bases (page 8).

⁽²⁾ Condenser pressure drop in the water circuit.

⁽³⁾ A3 refrigerant charge less than 0.5 kg, units exempt from, Regulation (EU) No 517/2014.

⁽⁴⁾ Recommended air cooler model to combine with the evaporator unit.

Electrical interconnections

For the electrical interconnection from the electrical panel to the unit and to the air condenser (optional), the following interconnection cables must be provided:

	230 V-I-50 Hz	400 V-III-50 Hz
Evaporator power supply	1 x 1.5 mm ² + N + T	3 x 1.5 mm ² + N + T
Compressor	1 x 1.5 mm ² + N + T	3 x 1.5 mm ² + N + T
Manoeuvre	4 x 1 mm ²	4 x 1 mm ²
Probes	4 x 1 mm ²	4 x 1 mm ²
Dry-cooler power supply	230 V-I-50 Hz	
Manoeuvre	2 x 1 mm ² + N + T	
Probes	2 x 1 mm ²	

Electrical board dimensions

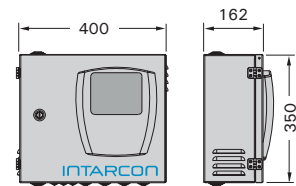

Waterloop *water-cooled condensing units*



- ❄ Indirect condensation by a water circuit.
- ❄ Low noise level.
- ❄ Simple installation.
- ❄ Reduced refrigerant load.
- ❄ According to F-Gas.

Water-cooled condensing units for positive temperature refrigeration, with very compact size and quiet operation, designed for on-wall or floor installation.

Features

- ▶ 230 V-I-50 Hz or 400 V-III-50 Hz power supply. Available in 60 Hz. Others voltages by request.
- ▶ Casing in pre-painted galvanized steel sheet, with noise insulation, with removable front panel for access to the compressor and the electrical panel.
- ▶ Acoustically insulated Scroll compressor, mounted on shock absorbers.
- ▶ Rotary compressor (MDM-P / BDM-P).
- ▶ Stainless steel brazed plates heat exchanger. Cooling circuit with ceramic dryer filter, sight glass, HP and LP and services valves.
- ▶ Hydraulic condensation circuit made of copper pipe with threaded connections.
- ▶ Electrical control panel with differential thermomagnetic protection.
- ▶ Liquid injection system for negative temperature models with R-449A.

Refrigeration and electrical sheme

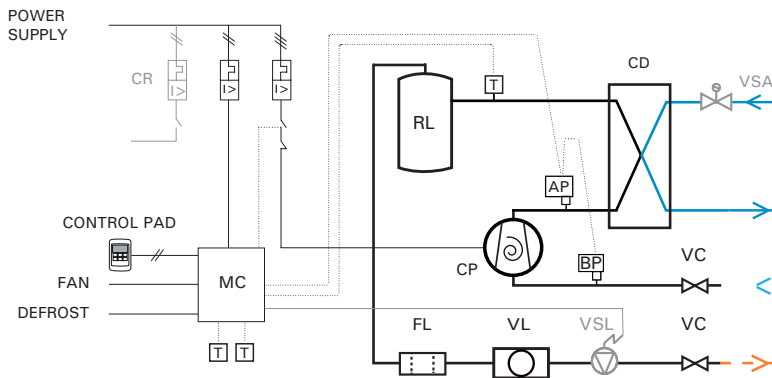

STANDARD

- AP: HIGH PRESSURE SWITCH
- BP: LOW PRESSURE SWITCH
- CD: HEAT EXCHANGER
- CP: COMPRESSOR
- FL: FILTER
- MC: MICRO-CONTROLLER
- RL: LIQUID VESSEL
- T: PROBE
- VC: SHUT-OFF VALVE
- VL: SIGHT GAUGE

OPTIONAL

- CR: DEFROST CONTACTOR
- VSA: WATER SOLENOID VALVE
- VSL: LIQUID SOLENOID VALVE
- OPTIONAL WITH ELECTRONIC CONTROL
- MC: ELECTRONIC MICRO-CONTROLLER

Installation

Waterloop series motor condensers can be installed on the furniture, on the floor or anchored at the wall.

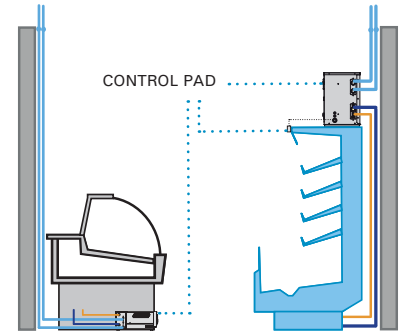

Rotary compressors

Hermetic rotary compressors provide greater reliability, lower noise and maximum design flexibility.



Very quiet compressors

Scroll compressors Copeland, are characterized by their great robustness and reliability of operation, and being cooled exclusively by the refrigerant gas, allow effective soundproofing.



Calculation of hydraulic connections

Visit our easy and intuitive online software to calculate the hydraulic pipes of the system.

<https://intarcon.calcooling.com/>

230 V-I-50 Hz / 400 V-III-50 Hz | Positive temperature | Rotary compressor - Scroll compressor | R-134a / R-449A

Series / Model	Compressor			Cooling capacity (W) ⁽¹⁾				Input power (kW)	Max. current (A)	Condensing flow (l/h)	Hydraulic connection	Pressure drop (mca)	Liq-Gas cooling connection	Weight (kg)	SPL dB(A) ⁽²⁾ 1 m	Price without electronic control (€)
	HP	Model	Power supply	Evaporation temperature												
				0 °C	-5 °C	-10 °C										
R-134a	1x R	MDM-PY-0 005	3/8 HGA-4450Y	230 V-I	820	690	570	0.4	4	150	3/4"	0.5	3/16"-3/8"	20	36	1 409
		MDM-PY-0 007	1/2 HGA-4476Y	230 V-I	1 220	1 020	850	0.5	5	250	3/4"	0.5	3/16"-1/2"	25	45	1 712
	1x Scroll	MDM-SY-1 009	1 1/4 ZS09	400 V-III *	1 840	1 540	1 270	0.7	3	350	3/4"	0.5	1/4"-5/8"	34	40	2 683
		MDM-SY-1 015	2 ZB15	400 V-III *	2 810	2 350	1 940	1.1	5	500	3/4"	0.5	1/4"-5/8"	43	37	3 381
		MDM-SY-1 021	3 ZB21	400 V-III *	4 200	3 500	2 890	1.5	7	750	3/4"	0.5	1/4"-3/4"	53	40	3 765
		MDM-SY-1 029	4 ZB29	400 V-III	5 200	4 340	3 590	2.0	10	950	1"	0.5	3/8"-7/8"	53	40	4 242
		MDM-SY-1 038	5 ZB38	400 V-III	7 060	5 890	4 860	2.5	13	1 250	1"	0.5	3/8"-7/8"	68	53	4 646
		MDM-SY-1 045	6 ZB45	400 V-III	8 250	6 890	5 700	2.9	13	1 500	1"	0.5	3/8"-1 1/8"	70	43	4 899
R-449A	1x R	MDM-PG-0 006	1/2 HGA-4467Z	230 V-I	1 190	960	765	0.5	5	200	3/4"	0.5	3/16"-3/8"	22	38	1 419
		MDM-PG-0 010	1 HGA-4512Z	230 V-I	2 000	1 610	1 290	0.8	7	350	3/4"	0.5	1/4"-1/2"	27	41	1 773
	1x Scroll	MDM-SG-1 009	1 1/4 ZS09	400 V-III *	2 790	2 250	1 840	1.2	2	500	1"	0.5	1/4"-5/8"	34	40	2 891
		MDM-SG-1 015	2 ZB15	400 V-III *	4 320	3 640	3 050	1.7	5	800	1"	0.5	3/8"-5/8"	43	37	3 220
		MDM-SG-1 021	3 ZB21	400 V-III *	6 330	5 340	4 460	2.4	7	1 200	1"	0.5	3/8"-3/4"	53	40	3 586
		MDM-SG-1 029	4 ZB29	400 V-III	7 787	6 580	5 510	3.1	10	1 500	1/4"	0.5	3/8"-7/8"	53	40	4 039
		MDM-SG-1 038	5 ZB38	400 V-III	10 500	8 870	7 430	3.9	13	1 950	1/4"	0.5	3/8"-7/8"	68	53	4 424
		MDM-SG-1 045	6 ZB45	400 V-III	13 100	11 200	9 420	5.6	13	2 500	1/4"	0.5	3/8"-1 1/8"	70	43	4 839

230 V-I-50 Hz / 400 V-III-50 Hz | Negative temperature | Rotary compressor - Scroll compressor | R-449A

Series / Model	Compressor			Cooling capacity (W) ⁽¹⁾				Input power (kW)*	Max. current (A)	Condensing flow (l/h)	Hydraulic connection	Pressure drop (mca)	Liq-Gas cooling connection	Weight (kg)	SPL dB(A) ⁽²⁾ 1 m	Price without electronic control (€)	
	HP	Model	Power supply	Evaporation temperature													
				-20 °C	-25 °C	-30 °C	-35 °C										
R-449A	1x Scroll	BDM-PG-0 004	1 HGA-2446Z	230 V-I	890	680	510	370	0.5	5	150	1/2"	0.5	3/16"-1/2"	23	45	2 110
		BDM-SG-1 006	2 ZF06	400 V-III *	2 240	1 840	1 500	1 210	1.6	5	550	3/4"	0.5	1/4"-5/8"	45	39	4 203
		BDM-SG-1 009	3 ZF09	400 V-III	3 120	2 560	2 080	1 660	2.0	6	700	3/4"	0.5	3/8"-3/4"	54	44	4 812
		BDM-SG-1 011	3 1/2 ZF11	400 V-III	3 843	3 180	2 580	2 070	2.4	8	850	3/4"	0.5	3/8"-3/4"	55	45	5 012
		BDM-SG-2 013	4 ZF13	400 V-III	4 320	3 560	2 900	2 340	2.7	9	950	1"	0.5	3/8"-7/8"	55	47	5 188
		BDM-SG-2 015	5 ZF15	400 V-III	5 400	4 440	3 600	2 890	3.5	10	1 200	1"	0.5	3/8"-7/8"	73	47	5 686
		BDM-SG-2 018	6 ZF18	400 V-III	6 460	5 300	4 300	3 450	4.1	14	1 500	1"	0.5	3/8"-1 1/8"	78	47	6 276
		BDM-SG-2 025	8 ZF25	400 V-III	8 060	6 640	5 390	4 330	4.5	16	1 750	1 1/4"	0.5	3/8"-1 1/8"	78	47	7 490

Options

- ▶ Change to 230 V-I-50 Hz power supply. + 8 %
- ▶ Electronic control for evaporator and compressor with temperature probes and control suitable for local or remote control. + 5 %
- ▶ Refrigerant pre-load for 5 m piping. + 8 %
- ▶ Built-in liquid solenoid valve with body and coil. + 152 €
- ▶ Water solenoid valve. + 152 €
- ▶ Flow regulation manual valve. + 53 €
- ▶ Hot gas defrost. By request

⁽¹⁾ Cooling capacity at nominal performances refer to operation at evaporation temperature -10 °C (PT) and -30 °C (NT), water temperature of 40 °C, 10 K super-heating and 3 K sub-cooling.

⁽²⁾ Sound pressure in dB (A) in open field at 1 m from the unit.

* Available units with 230 V-I-50 Hz power supply.

Dimensions

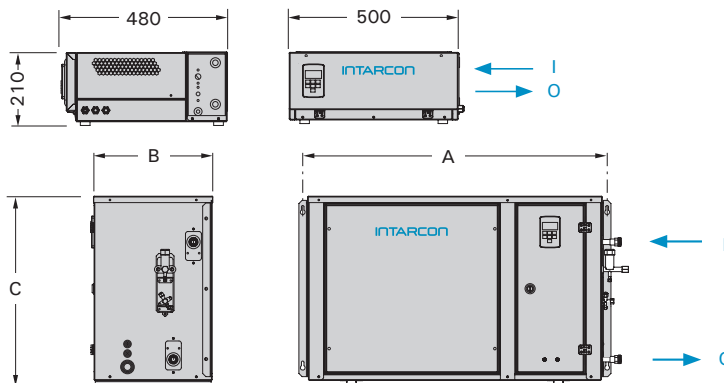

Measuring mm.

Waterloop dry-cooler with built-in hydraulic group

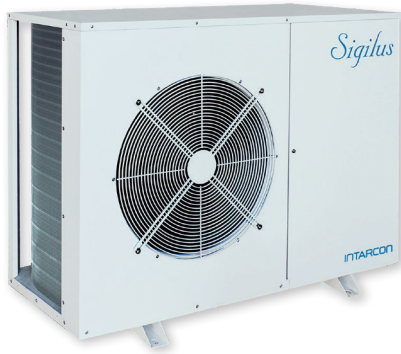

- ❄ Low sound level with double acoustic insulation.
- ❄ Tropicalised design for ambient temperature up to 45 °C as standard.

Dry-coolers with built-in hydraulic group, in a low-noise construction, designed for heat dissipation of the refrigeration equipment condensation waterloop.

Features

- ▶ Axial EC motor fans (except CWF-0 and CWF-1).
- ▶ High efficiency water coils with copper pipes and aluminium fins.
- ▶ Hydraulic group with variable flow electronic pump, expansion valve, security valve, filter, thermomanometers and auto-fill valve included.
- ▶ Threaded hydraulic connections.
- ▶ Electric power panel with protection of hydraulic pump, fan motor and speed regulator (except CWF-0 and CWF-1).

Electronic control

Waterloop dry-coolers (CWF-2 up to 8) incorporate an electronic control with the next functions:

- Variation of the water pump flow adapting to the demand, depending on the impulsion pressure.
- Waterloop temperature control by fan speed variation, with floating set-point.
- Frost protection.

230 V-I-50 Hz | Positive temperature | Water

Series / Model	Flow control	Exchange capacity (W) ⁽¹⁾	Air flow (m³/h)	Fan (N x Ø mm)	Water flow (l/h)	Input power (kW)	Max. current (A)	Pressure drop kPa ⁽²⁾	Hydraulic connection	Weight (kg)	SPL dB(A) ⁽³⁾	Price (€)
CWF-0	Constant	3 000	1 700	1x Ø 360	500	0.14	1.1	100	3/4"	76	30	1 662
CWF-1	Constant	4 700	3 200	1x Ø 450	750	0.22	1.8	100	3/4"	79	26	2 812
CWF-2	Variable	6 000	3 700	1x Ø 450	1 000	0.24	2.0	100	1"	81	26	3 837
CWF-3	Variable	10 000	6 500	2x Ø 450	1 500	0.44	3.6	100	1"	101	29	5 172
CWF-4	Variable	12 000	7 000	2x Ø 450	2 000	0.48	3.9	100	1 1/4"	113	29	5 627
CWF-6	Variable	20 000	13 000	4x Ø 450	3 000	0.88	7.0	100	1 1/2"	160	32	9 459
CWF-8	Variable	24 000	14 000	4x Ø 450	4 000	0.96	7.5	100	1 1/2"	185	32	12 582

Options

- ▶ Water coil anti-corrosion polyurethane coating. + 8 %
- ▶ Coil protection grille:
Series 0 up to 4. + 95 €
Series 6 and 8. + 168 €

⁽¹⁾ Estimated heat exchange power with air temperature of 35 °C, and water inlet / outlet temperature of 45 / 40 °C.
⁽²⁾ Available circuit pressure.
⁽³⁾ Sound pressure in dB (A) in open field at 10 m from the unit.

Dimensions

Dimensions (mm)	A	B	C
0 and 1 series	1 030	374	577
2 series	1 080	415	827
3 series	1 150	481	1 097
4 series	1 150	481	1 347
6 series	1 744	481	1 097
8 series	1 744	481	1 347

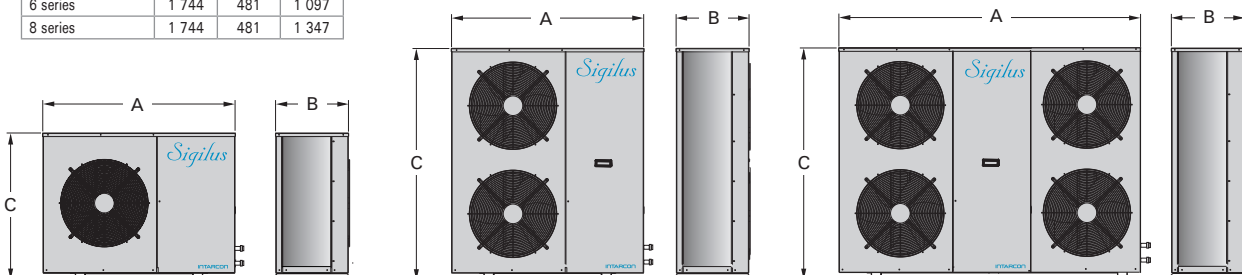



Condensing units



Complies with Ecodesign



VRC multi-service version



Low noise construction



Low noise condensing units for positive and negative refrigeration with hermetic alternative compressor with noise insulation and low speed axial motor fan.

Features

- ▶ 230 V-I-50 Hz or 400 V-III-50 Hz power supply. Available in 60 Hz. Others voltages by request.
- ▶ R-134a or R-449A refrigerant, other refrigerants by request.
- ▶ Reciprocating hermetic compressor, acoustically insulated with discharge muffler, mounted on shock absorbers, with crankcase heater and internal klixon.
- ▶ Large-surface condensing coil made of copper tubes and aluminium fins, with tropicalised dimensioning for ambient temperatures up to 50 °C.
- ▶ Low speed axial motor fan.
- ▶ Refrigeration circuit equipped with high and low pressure switches, ceramic filter and sight gauge.
- ▶ Digital control of condensation pressure with the optional electrical board, and all-nothing condensation control in condensers without electrical panel.
- ▶ Proportional control of condensing pressure through fan speed variation (included from MDF-NY-2086 and MDF-NG-1038 without electronic control).
- ▶ Full control and power board with compressor and motor fan protection.
- ▶ Evaporator electronic control board (-N version with optional electrical board).
- ▶ Built-in oil separator (-V multi-service version).
- ▶ Liquid injection system for negative temperature models with R-449A.

Versions

- ▶ **-N version:** Without electrical board. Designed for on/off operation depending on the suction pressure (pump-down). With electrical board as an option. Electronic controller to manage the condensing unit and the evaporator built-in solenoid valve as an option.
- ▶ **-V version (multi-service):** The multi-service version features VRC system to adjust the refrigerant flow to the demand of the evaporators, keeping the pressure constant in suction the line. The VRC system is composed of a set of pressure and temperature regulation valves to progressively modulate cooling capacity from 100 % to 10 % of its nominal capacity, while reducing energy consumption and preventing compressor overheating.

- ❄ Tropicalised design for high ambient temperature up to 50 °C.
- ❄ Multi-service version with VRC cooling capacity modulation system.
- ❄ Liquid injection system for compressor refrigeration.

Installation without electrical board (-N version)

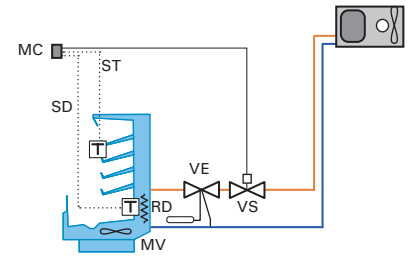

- MC: CONTROL PAD
- MV: MOTOR FAN
- RD: DEFROST HEATER
- ST: THERMOSTAT PROBE
- SD: DEFROST PROBE
- VE: EXPANSION VALVE
- VS: SOLENOID VALVE

Oil separator (optional)

Sigilus condensing units connected to a single evaporator usually not require an oil separator. This is recommended for long pipe lengths (> 30 m) being necessary for a suitable circuit design to ensure oil return.

Proportional condensation control

Sigilus condensing units incorporate proportional condensation control by speed variation for prolonged running times at low ambient temperature.

Triple noise insulation

Sigilus units incorporate triple noise insulation as standard:

- Insulated compressor compartment separated from air flow.
- Acoustic compressor jacket (three-phase models) and discharge muffler (hermetic models).
- Low-noise and low-speed fans, mounted on shock absorbers.

230 V-I-50 Hz / 400 V-III-50 Hz | Positive temp. | Low-noise condensing units | Hermetic compressor | R-134a / R-449A

Series / Model	Compressor		Cooling capacity EN13215 (W) ⁽¹⁾ Evap. temp. -10 °C	Cooling capacity (W) ⁽²⁾ Evaporation temperature				Input power (kW)	(COP) SEPR ⁽³⁾	Max. current (A)	Fan Ø mm	Flow (m³/h)	Liq-Gas cooling connection	Weight (kg)	SPL dB(A) ⁽⁴⁾	Price without electronic control (€)	
	HP	Power supply		0 °C	-5 °C	-10 °C	-15 °C										
R-134a	MDF-NY-0 010	3/8	230 V-I	590	870	700	560	430	0.33	(1.75)	4.0	Ø 200	350	1/4"-3/8"	50	28	1 622
	MDF-NY-0 015	1/2	230 V-I	830	1 200	970	770	610	0.46	(1.73)	5.0	Ø 200	350	1/4"-3/8"	52	29	1 731
	MDF-NY-1 015	1/2	230 V-I	890	1 380	1 100	860	650	0.49	(1.78)	5.0	Ø 360	1 700	1/4"-1/2"	66	31	1 828
	MDF-NY-1 026	3/4	230 V-I	1 370	2 140	1 700	1 310	970	0.71	(1.89)	9.0	Ø 360	1 700	1/4"-1/2"	74	31	1 949
	MDF-NY-1 033	1	230 V-I	1 780	2 680	2 150	1 680	1 250	0.82	(2.10)	9.0	Ø 360	1 700	1/4"-5/8"	76	31	2 217
	MDF-NY-1 053	1 1/2	230 V-I *	2 450	3 900	3 060	2 320	1 720	1.22	(1.96)	12.0	Ø 360	1 700	1/4"-3/4"	88	32	2 629
	MDF-NY-1 074	2	230 V-I *	3 510	5 260	4 200	3 260	2 470	1.60	(2.11)	16.0	Ø 360	1 700	1/4"-3/4"	90	36	3 309
	MDF-NY-2 086 ^(v)	4	400 V-III	4 380	6 670	5 260	4 050	3 030	1.81	(2.32)	13.0	Ø 450	3 600	3/8"-7/8"	98	38	3 714
	MDF-NY-2 108 ^(v)	5	400 V-III	5 370	8 060	6 370	4 900	3 740	2.20	3.25	16.0	Ø 450	3 600	3/8"-7/8"	100	35	3 935
R-449A	MDF-NY-2 136 ^(v)	6 1/2	400 V-III	6 850	10 180	8 250	6 500	5 040	2.99	2.89	19.0	Ø 450	3 600	3/8"-1 1/8"	103	34	4 514
	MDF-NG-0 008	1/3	230 V-I	620	980	810	650	510	0.37	(1.72)	4.0	Ø 200	350	1/4"-3/8"	51	28	1 528
	MDF-NG-0 010	3/8	230 V-I	800	1 230	1 020	820	650	0.48	(1.72)	5.0	Ø 200	350	1/4"-3/8"	51	29	1 631
	MDF-NG-0 012	1/2	230 V-I	950	1 420	1 180	960	770	0.56	(1.73)	6.0	Ø 200	350	1/4"-3/8"	51	29	1 724
	MDF-NG-1 014	1/2	230 V-I	1 160	1 920	1 560	1 240	960	0.68	(1.74)	6.0	Ø 360	1 700	1/4"-1/2"	66	32	1 837
	MDF-NG-1 016	5/8	230 V-I	1 320	2 250	1 820	1 440	1 080	0.76	(1.80)	7.0	Ø 360	1 700	1/4"-1/2"	76	32	1 984
	MDF-NG-1 018	3/4	230 V-I	1 650	2 690	2 190	1 750	1 360	0.92	(1.87)	8.0	Ø 360	1 700	1/4"-1/2"	76	32	2 088
	MDF-NG-1 024	1	230 V-I	2 110	3 560	2 890	2 280	1 720	1.06	(2.07)	12.0	Ø 360	1 700	3/8"-5/8"	78	32	2 289
	MDF-NG-1 026	1 1/4	230 V-I *	2 370	3 870	3 160	2 530	1 950	1.18	(2.08)	13.0	Ø 360	1 700	3/8"-5/8"	78	32	2 340
	MDF-NG-1 034	1 1/2	230 V-I *	3 060	4 860	3 980	3 200	2 500	1.66	(1.90)	16.0	Ø 360	1 700	3/8"-5/8"	78	32	2 419
	MDF-NG-1 038 ^(v)	1 3/4	400 V-III	3 360	5 870	4 740	3 720	2 830	1.60	(2.15)	7.0	Ø 450	3 200	3/8"-5/8"	81	29	2 945
MDF-NG-2 048 ^(v)	2	400 V-III	4 360	6 990	5 670	4 530	3 530	1.98	(2.26)	8.0	Ø 450	3 600	3/8"-3/4"	85	26	3 307	
MDF-NG-2 054 ^(v)	2 1/2	400 V-III	4 840	7 860	6 420	5 160	4 070	2.18	(2.34)	9.0	Ø 450	3 600	3/8"-3/4"	86	26	3 501	
MDF-NG-2 060 ^(v)	3	400 V-III	5 800	8 850	7 290	5 900	4 700	2.59	3.24	10.0	Ø 450	3 600	3/8"-3/4"	87	26	3 821	
MDF-NG-2 068 ^(v)	3 1/2	400 V-III	6 550	9 810	8 150	6 630	5 300	2.97	3.10	10.0	Ø 450	3 600	1/2"-3/4"	88	25	4 015	

230 V-I-50 Hz / 400 V-III-50 Hz | Negative temperature | Low-noise condensing units | Hermetic compressor | R-449A

Series / Model	Compressor		Cooling capacity EN13215 (W) ⁽¹⁾ Evap. temp. -35 °C	Cooling capacity (W) ⁽²⁾ Evaporation temperature			Input power (kW)	(COP) SEPR ⁽³⁾	Max. current (A)	Fan Ø mm	Flow (m³/h)	Liq-Gas cooling connection	Weight (kg)	SPL dB(A) ⁽⁴⁾	Price without electronic control (€)	
	HP	Power supply		-25 °C	-30 °C	-35 °C										
R-449A	BDF-NG-0 018	5/8	230 V-I	370	800	600	420	0.44	(0.96)	6.0	Ø 200	350	1/4"-1/2"	61	28	2 128
	BDF-NG-1 026	3/4	230 V-I	590	1 310	950	670	0.69	(0.96)	9.0	Ø 360	1 700	1/4"-1/2"	67	31	2 580
	BDF-NG-1 034	1 1/4	230 V-I	780	1 720	1 260	880	0.93	(0.95)	10.0	Ø 360	1 700	3/8"-5/8"	83	32	2 930
	BDF-NG-1 055	1 3/4	230 V-I *	990	2 350	1 670	1 114	1.10	(0.97)	16.0	Ø 360	1 700	3/8"-5/8"	93	34	3 309
	BDF-NG-1 075	2 1/2	230 V-I *	1 430	3 050	2 286	1 586	1.50	(1.04)	24.0	Ø 360	1 700	3/8"-5/8"	93	36	3 372
	BDF-NG-2 096	3 1/2	400 V-III	1 800	4 130	2 990	2 020	1.67	(1.18)	11.0	Ø 450	3 600	3/8"-3/4"	98	39	4 553
	BDF-NG-2 108	4	400 V-III	2 240	4 790	3 560	2 470	2.05	1.67	13.0	Ø 450	3 600	3/8"-7/8"	98	37	4 872
	BDF-NG-2 136	5	400 V-III	2 950	5 970	4 490	3 230	2.72	1.60	15.0	Ø 450	3 600	3/8"-7/8"	98	32	5 189
	BDF-NG-3 215	7 1/2	400 V-III	4 500	9 300	6 970	4 940	4.03	1.68	24.0	2x Ø 450	6 500	1/2"-1 1/8"	149	39	6 559
	BDF-NG-3 271	10	400 V-III	6 380	11 960	9 160	6 760	5.36	1.70	28.0	2x Ø 450	6 500	1/2"-1 1/8"	149	39	6 844

Options

- ▶ Change to 400 V-III-50 Hz power supply. + 8 %
- ▶ Built-in oil separator (already included in -V version). + 617 €
- ▶ Built-in solenoid valve with body and coil (except -V version). + 152 €
- ▶ Anti-corrosion coil coating. + 8 %
- ▶ Coil protection grille. + 95 €
- ▶ Proportional condensation control by fan speed variator (1 series). + 262 €
- ▶ Control and power panel with electronic control unit for management of condenser and evaporator. + 5 %
- ▶ Larger sized multifunction electronic control. + 157 €

Versions

- ▶ Version V - Multi-service version with VRC system (with oil separator). Table models with ^(v). + 1 000 €

⁽¹⁾ Conditions based on UNE-EN 13215: ambient temp. 32 °C, evap. temp. -10 °C (PT) and -35 °C (NT), 20 °C of suction temperature, refrigerant R-449A.

⁽²⁾ Cooling capacity in nominal conditions: evaporating temp -10 °C (PT) and -35 °C (NT), ambient temperature of 32 °C, overheating 10 K, refrigerant R-449A.

⁽³⁾ COP/SEPR: : Coefficient of Performance according to Ecodesign Directive 2015/1095/EU ErP 2015/1095/UE.

	Cooling capacity	Ecodesign
L	0,2 < P ≤ 1 kW	COP ≥ 1,40
	1 < P ≤ 5 kW	COP ≥ 1,60
	5 < P ≤ 20 kW	SEPR ≥ 2,55
M	P ≤ 2 kW	COP ≥ 0,95
	2 < P ≤ 8 kW	SEPR ≥ 1,60

⁽⁴⁾ Sound pressure in dB (A) in open field at 10 m from the unit.

^(v) Model that allow VRC system.

* Available units with 400 V-III-50 Hz power supply.

Scheme

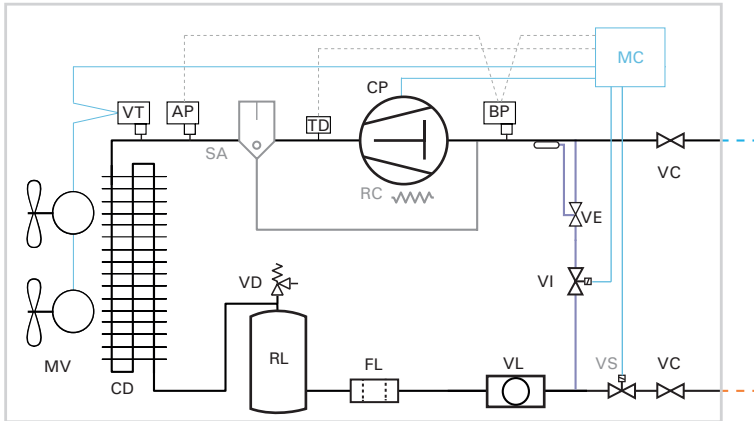

STANDARD

- AP: HIGH PRESSURE SWITCH
- BP: LOW PRESSURE SWITCH
- CD: CONDENSER
- CP: COMPRESSOR
- FL: FILTER
- MV: MOTOR FAN
- RL: LIQUID VESSEL
- RC: CRANKCASE HEATER
- VC: SERVICE VALVE
- VD: SECURITY VALVE (UP TO 1 HP)
- VL: SIGHT GAUGE
- VT: VOLTAGE REGULATOR

OPTIONAL

- SA: OIL SEPARATOR
- VS: SOLENOID VALVE
- LIQUID INJECTION SYSTEM (ONLY BDF)
- TD: DISCHARGE THERMOSTAT
- VE: THERMOSTATIC EXPANSION VALVE
- VI: LIQUID SOLENOID VALVE

ADDITIONAL -N VERSION

- MC: ELECTRONIC MICRO-CONTROLLER

Dimensions (DF)

0 series

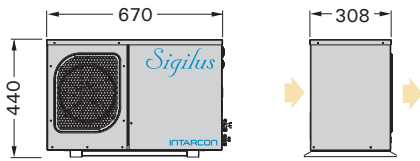

1 series

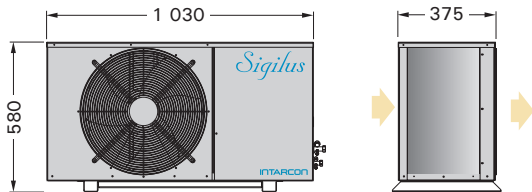

2 series

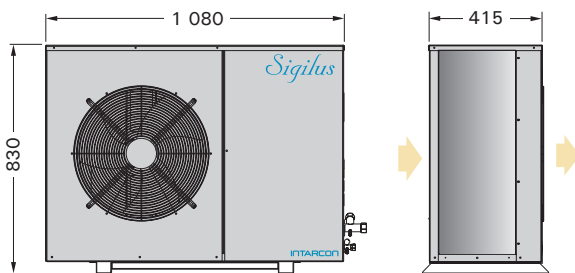

3 series

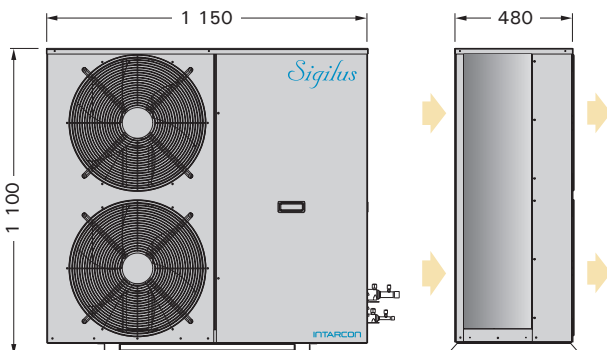

Measuring mm.

MDF-N and BDF-N (with optional electronic control)

Sigilus condensing units with optional electronic control incorporate an advanced electronic controller XM670K for the management of the condensing unit and the evaporator, being able to optionally integrate the solenoid valve.



- Multifunction remote digital control.
- Electronic board integrated in the condensing unit for 6 control relays for: compressor, condensing fan, evaporator fan, defrost, light and alarm.
- Possibility of interconnection and synchronization of up to 8 devices by LAN, managed from a single control.

Liquid injection system

Negative temperature condensing units incorporate a safety cooling system for the motor by liquid injection into the compressor suction.

R-499A and R-448A refrigerants have high gas discharge temperature under conditions of high compression ratio and high suction gas superheat.

To protect the motor windings and preserve oil stability, compressor cooling is necessary in certain situations.

intarbox



Air-cooled packaged condensing units at positive or negative temperature, in horizontal construction with an alternative hermetic compressor, and low speed axial or centrifugal motor fan.

Features

- ▶ 230 V-I-50 Hz or 400 V-III-50 Hz power supply. Available in 60 Hz. Others voltages by request.
- ▶ R-134a or R-449A refrigerant, other refrigerants by request.
- ▶ Hermetic reciprocating compressor mounted on shock absorbers, with discharge muffler and internal klixon.
- ▶ High performance condensing coil in copper pipes and aluminium fins.
- ▶ Centrifugal motor fan with available static pressure for a ducted outlet of condenser hot air (centrifugal version).
- ▶ Refrigeration circuit equipped with HP and LP switches, filter dryer, liquid receiver and sight gauge.
- ▶ Digital control of condensation pressure with the optional electrical board, and all-nothing condensation control with condensers without electrical panel.
- ▶ Proportional control of condensing pressure through fan speed variation (included in MDH series 4).
- ▶ Full control and power board with compressor and motor fan protection.
- ▶ Electronic regulation with evaporator control pad (-N version with optional electrical board).
- ▶ Built-in oil separator (-V multi-service version).
- ▶ Liquid injection system for negative temperature models with R-449A.

Versions

- ▶ **Version -N:** Without electrical board. Designed for on/off operation depending on the suction pressure (pump-down). With electrical board as an option. Electronic controller to manage the condensing unit and the evaporator built-in solenoid valve as an option.
- ▶ **Version -V (multi-service):** The multi-service version features VRC system to adjust the refrigerant flow to the demand of the evaporators, keeping the pressure constant in suction the line. The VRC system is composed of a set of pressure and temperature regulation valves to progressively modulate cooling capacity from 100 % to 10 % of its nominal capacity, while reducing energy consumption and preventing compressor overheating.

- ❄ **Designed for ambient temperature up to 45 °C.**
- ❄ **Multi-service version with VRC cooling capacity modulation system.**
- ❄ **Liquid injection system for compressor refrigeration.**

Installation scheme (-C version with electronic control)

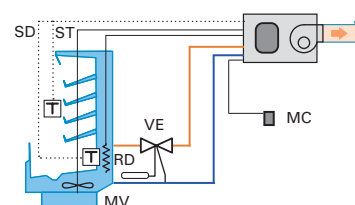

- MC: CONTROL PAD
- MV: MOTOR FAN
- RD: DEFROST HEATER
- ST: THERMOSTAT PROBE
- SD: DEFROST PROBE
- VE: EXPANSION VALVE
- VS: SOLENOID VALVE

Centrifugal fan (centrifugal version)

intarbox condensing units feature centrifugal motor fans for a ducted outlet of condenser hot air.

AVAILABLE STATIC PRESSURE (mmca)

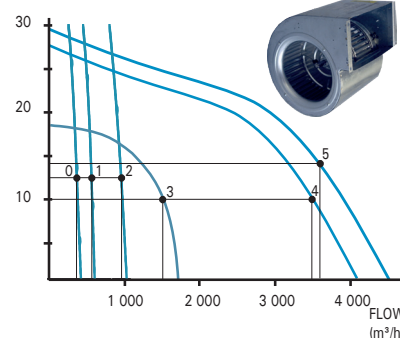

Exhaust duct

Recommended size for 20 m long steel, PVC or fibreglass ducts (each elbow equals 5 m length). For flexible or semi-flexible ducts use a larger size.

- 0 series: 200 x 150 mm or Ø 150 mm
- 1 series: 200 x 200 mm or Ø 150 mm
- 2 series: 250 x 150 mm or Ø 200 mm
- 3 series: 200 x 300 mm or Ø 250 mm
- 4 and 5 series: 350 x 400 mm or Ø 360 mm

230 V-I-50 Hz / 400 V-III-50 Hz | **Positive temperature** | Hermetic compressor | **R-134a / R-449A**

Axial version Series / Model	Compressor HP	Power supply	Cooling capacity EN13215 (W) ⁽¹⁾ Evap. temp. -10 °C	Cooling capacity (W) ⁽²⁾ Evaporation temperature				Input power (kW)	(COP) SEPR ⁽³⁾	Max. current (A)	Liq-Gas cooling connection	Weight (kg)	SPL dB(A) ⁽⁴⁾	Price without electronic control (€)	Centrifugal version Series / Model	Flow (m³/h)	ASP (mmca) ⁽⁵⁾	Price without electronic control (€)	
				0 °C	-5 °C	-10 °C	-15 °C												
R-134a	MDH-NY-0 010	3/8	230 V-I	590	880	710	560	430	0.37	(1.54)	4.0	1/4"-3/8"	37	29	1 316	MDH-CY-0 010	375	8	1 507
	MDH-NY-0 015	1/2	230 V-I	830	1 210	980	780	600	0.51	(1.58)	5.0	1/4"-3/8"	40	32	1 445	MDH-CY-0 015	375	8	1 700
	MDH-NY-1 015	1/2	230 V-I	870	1 290	1 040	820	625	0.50	(1.69)	5.0	1/4"-1/2"	41	32	1 505	MDH-CY-1 015	575	8	1 814
	MDH-NY-1 026	3/4	230 V-I	1 270	1 890	1 520	1 190	920	0.72	(1.72)	9.0	1/4"-1/2"	48	30	1 794	MDH-CY-1 026	575	8	1 938
	MDH-NY-1 033	1	230 V-I	1 630	2 310	1 880	1 500	1 170	0.84	(1.87)	9.0	1/4"-1/2"	50	33	1 847	MDH-CY-1 033	575	8	2 283
	MDH-NY-2 053	1 1/2	230 V-I *	2 250	3 470	2 760	2 120	1 560	1.25	(1.77)	12.0	1/4"-5/8"	63	38	2 351	MDH-CY-2 053	1 000	12	2 779
	MDH-NY-3 074	2	230 V-I *	3 410	5 080	4 080	3 180	2 390	1.61	(2.06)	16.0	1/4"-3/4"	84	44	2 883	MDH-CY-3 074	1 500	14	3 175
	MDH-NY-4 086 ⁽⁶⁾	4	400 V-III	4 310	6 620	5 240	4 040	3 040	1.97	(2.13)	14.0	3/8"-5/8"	107	48	3 435	MDH-CY-4 086 ⁽⁶⁾	3 500	10	4 354
	MDH-NY-4 108 ⁽⁶⁾	5	400 V-III	5 260	7 920	6 350	4 910	3 690	2.39	2.88	17.0	3/8"-7/8"	109	45	3 835	MDH-CY-4 108 ⁽⁶⁾	3 500	10	4 751
	MDH-NY-4 136 ⁽⁶⁾	6 1/2	400 V-III	6 700	9 570	7 810	6 210	4 730	3.24	2.59	20.0	3/8"-1 1/8"	112	44	4 193	MDH-CY-4 136 ⁽⁶⁾	3 500	10	5 112
R-449A	MDH-NG-0 008	1/3	230 V-I	620	990	810	650	510	0.42	(1.53)	4.0	1/4"-3/8"	46	31	1 215	MDH-CG-0 008	375	8	1 385
	MDH-NG-0 010	3/8	230 V-I	800	1 250	1 030	830	660	0.52	(1.57)	5.0	1/4"-3/8"	46	34	1 253	MDH-CG-0 010	375	8	1 538
	MDH-NG-0 012	1/2	230 V-I	950	1 435	1 190	980	780	0.60	(1.61)	6.0	1/4"-3/8"	46	34	1 313	MDH-CG-0 012	375	8	1 644
	MDH-NG-1 014	1/2	230 V-I	1 150	1 770	1 460	1 190	950	0.69	(1.69)	6.0	1/4"-1/2"	50	34	1 428	MDH-CG-1 014	575	8	1 709
	MDH-NG-1 016	5/8	230 V-I	1 290	2 020	1 660	1 340	1 040	0.78	(1.71)	7.0	1/4"-1/2"	60	34	1 587	MDH-CG-1 016	575	8	1 826
	MDH-NG-1 018	3/4	230 V-I	1 560	2 360	1 960	1 600	1 270	0.94	(1.72)	8.0	1/4"-1/2"	60	34	1 668	MDH-CG-1 018	575	8	2 004
	MDH-NG-2 024	1	230 V-I	2 070	3 270	2 680	2 150	1 680	1.10	(1.93)	12.0	3/8"-5/8"	60	35	1 832	MDH-CG-2 024	1 000	12	2 298
	MDH-NG-2 026	1 1/4	230 V-I *	2 300	3 550	2 930	2 370	1 870	1.24	(1.91)	13.0	3/8"-5/8"	61	36	1 860	MDH-CG-2 026	1 000	12	2 475
	MDH-NG-2 034	1 1/2	230 V-I *	2 870	4 300	3 590	2 920	2 310	1.73	(1.71)	16.0	3/8"-5/8"	61	37	1 915	MDH-CG-2 034	1 000	12	2 592
	MDH-NG-3 038 ⁽⁶⁾	1 3/4	400 V-III	3 270	4 970	4 100	3 310	2 610	1.56	(2.12)	6.0	3/8"-5/8"	78	40	2 419	MDH-CG-3 038 ⁽⁶⁾	1 500	14	3 337
MDH-NG-4 048 ⁽⁶⁾	2	400 V-III	4 330	6 850	5 580	4 460	3 490	2.14	(2.08)	13.0	3/8"-3/4"	95	36	2 958	MDH-CG-4 048 ⁽⁶⁾	3 500	10	3 875	
MDH-NG-4 054 ⁽⁶⁾	2 1/2	400 V-III	4 970	7 660	6 300	5 070	4 010	2.38	(2.14)	14.0	3/8"-3/4"	96	36	3 310	MDH-CG-4 054 ⁽⁶⁾	3 500	10	4 229	
MDH-NG-4 060 ⁽⁶⁾	3	400 V-III	5 720	8 590	7 130	5 800	4 620	2.84	2.98	15.0	3/8"-3/4"	97	36	3 718	MDH-CG-4 060 ⁽⁶⁾	3 500	10	4 700	
MDH-NG-4 068 ⁽⁶⁾	3 1/2	400 V-III	6 450	9 490	7 920	6 500	5 210	3.26	2.87	15.0	1/2"-3/4"	98	35	3 827	MDH-CG-4 068 ⁽⁶⁾	3 500	10	5 230	

230 V-I-50 Hz / 400 V-III-50 Hz | **Negative temperature** | Hermetic compressor | **R-449A**

Axial version Series / Model	Compressor HP	Power supply	Cooling capacity EN13215 (W) ⁽¹⁾ Evap. temp. -35 °C	Cooling capacity (W) ⁽²⁾ Evaporation temperature				Input power (kW)	(COP) SEPR ⁽³⁾	Max. current (A)	Liq-Gas cooling connection	Weight (kg)	SPL dB(A) ⁽⁴⁾	Price without electronic control (€)	Centrifugal version Series / Model	Flow (m³/h)	ASP (mmca) ⁽⁵⁾	Price without electronic control (€)
				-25 °C	-30 °C	-35 °C												
R-449A	BDH-NG-1 026	3/4	230 V-I	590	1 220	930	670	0.69	(0.96)	9.0	1/4"-1/2"	51	31	1 944	BDH-CG-1 026	575	8	2 115
	BDH-NG-1 034	1 1/4	230 V-I	780	1 520	1 170	860	0.92	(0.95)	10.0	1/4"-1/2"	52	33	2 007	BDH-CG-1 034	575	8	2 165
	BDH-NG-2 055	1 3/4	230 V-I *	980	2 195	1 630	1 110	1.20	(0.95)	16.0	3/8"-5/8"	69	38	2 561	BDH-CG-2 055	1 000	12	2 750
	BDH-NG-2 075	2 1/2	230 V-I *	1 400	2 785	2 130	1 560	1.50	(1.02)	24.0	3/8"-5/8"	69	41	2 623	BDH-CG-2 075	1 000	12	2 811
	BDH-NG-3 096	3 1/2	400 V-III	2 080	3 663	2 733	1 940	1.69	(1.15)	11.0	3/8"-3/4"	88	49	3 793	BDH-CG-3 096	1 500	14	4 126
	BDH-NG-4 108	4	400 V-III	2 240	4 690	3 500	2 470	2.15	1.62	14.0	3/8"-7/8"	117	47	4 839	BDH-CG-4 108	3 500	10	5 221
	BDH-NG-5 136	5	400 V-III	2 950	6 080	4 560	3 230	2.83	1.61	16.0	3/8"-1 1/8"	152	42	6 493	BDH-CG-5 136	3 600	10	6 940
	BDH-NG-5 215	7 1/2	400 V-III	4 500	8 870	6 670	4 820	4.07	1.60	24.0	1/2"-1 1/8"	183	49	6 918	BDH-CG-5 215	3 600	10	7 384

Options

- ▶ Change to 400 V-III-50 Hz power supply. + 8 %
- ▶ Proportional control of condensing pressure through speed variation (axial 3 series and centrifugal 0 up to 3 series). + 262 €
- ▶ Built-in oil separator (already included in -V version). + 617 €
- ▶ Crankcase heater. + 63 €
- ▶ Built-in solenoid valve with body and coil (except for -V version). + 152 €
- ▶ Anti-corrosion coil coating. + 8 %
- ▶ Non-return damper (centrifugal version). + 27 €
- ▶ Adaptation of air discharge to circular duct. + 105 €
- ▶ Vertical discharge (centrifugal version).
- ▶ Control and power panel with electronic control unit for management of condenser and evaporator. + 5 %
- ▷ Larger sized multifunction electronic control. + 157 €

Versions

- ▶ **-V version** - Multi-service version with VRC system (with oil separator). Table models with ⁽⁶⁾. + 1 000 €

⁽¹⁾ Conditions based on UNE-EN 13215: ambient temp. 32 °C, evap. temp. -10 °C (PT) and -35 °C (NT), 20 °C of suction temperature, refrigerant R-449A.

⁽²⁾ Conditions based on UNE-EN 13215: ambient temp. 32 °C, evap. temp. -10 °C (PT) and -35 °C (NT), overheating 10 K, R-449A refrigerant.

⁽³⁾ COP / SEPR: Coefficient of Performance according to Ecodesign Directive 2015/1095/EU.

	Cooling capacity	Ecodesign
L	0,2 < P ≤ 1 kW	COP ≥ 1.40
	1 < P ≤ 5 kW	COP ≥ 1.60
M	5 < P ≤ 20 kW	SEPR ≥ 2.55
	P ≤ 2 kW	COP ≥ 0.95
	2 < P ≤ 8 kW	SEPR ≥ 1.60

⁽⁴⁾ Sound pressure in dB (A) in open field at 10 m from the unit.

⁽⁵⁾ Available static pressure condensation.

⁽⁶⁾ Model that allow VRC system.

⁽⁶⁾ Requires proportional control of condensing pressure.

* Units available with 400 V-III-50 Hz power supply.

Refrigeration scheme DH - Centrifugal

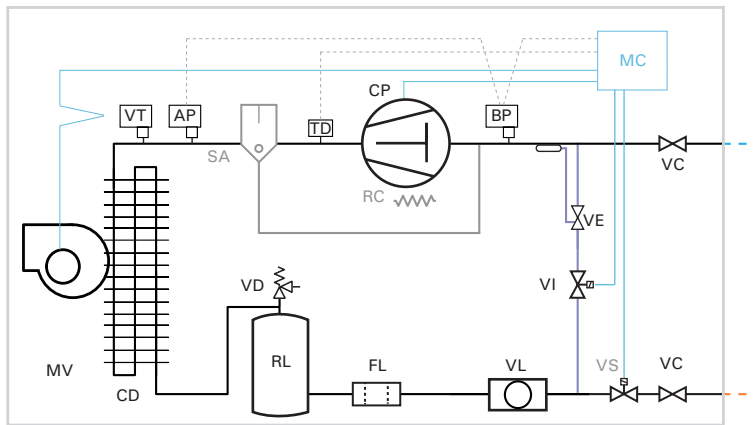

STANDARD

- CD: CONDENSER
- CP: COMPRESSOR
- FL: FILTER DRYER
- MV: MOTOR FAN
- RL: LIQUID RECEIVER
- VL: SIGHT GAUGE
- VC: 3 WAYS SERVICE VALVE (UP TO 3/4" CONNECTIONS)
- VD: SECURITY VALVE

OPTIONAL

- RC: CRANKCASE HEATER
- SA: OIL SEPARATOR
- VS: SOLENOID VALVE

LIQUID INJECTION SYSTEM (ONLY BDH)

- TD: DISCHARGE THERMOSTAT
- VE: EXPANSION VALVE
- VI: LIQUID SOLENOID VALVE

ADDITIONAL - N VERSION

- MC: ELECTRONIC MICRO-CONTROLLER

Dimensions DH - Axial

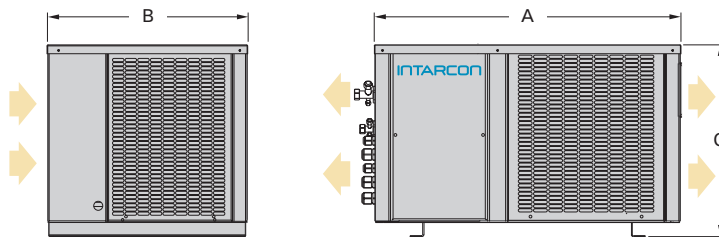

Dimensions (mm)	A	B	C
0 series	600	395	355
1 series	665	435	416
2 series	835	435	500
3 series	925	580	515
4 series	1 000	615	585
5 series	1 290	755	656

Dimensions DH - Centrifugal

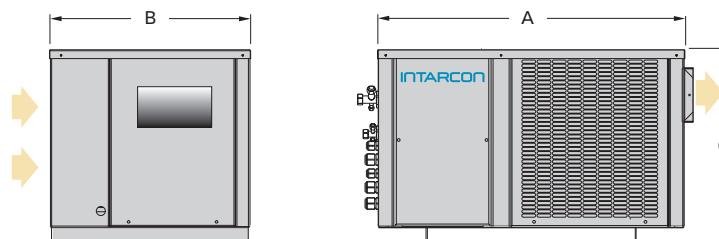

Dimensions (mm)	A	B	C	Fan outlet	Hopper
0 series	600	395	355	185 x 115	Ø 150
1 series	665	435	416	185 x 115	Ø 150
2 series	835	435	500	230 x 130	Ø 200
3 series	925	580	515	236 x 266	Ø 250
4 series	1 000	615	585	305 x 266	Ø 360
5 series	1 290	755	656	305 x 266	Ø 360

MDH-N and BDH-N (with optional electronic control)

intarbox condensing units with the optional electronic control incorporate an advanced electronic controller XM670K for the management of the condensing unit and the evaporator, being able to optionally integrate the solenoid valve.



- Multifunction remote digital control.
- Electronic board integrated in the condensing unit for 6 control relays for: compressor, condensing fan, evaporator fan, defrost, light and alarm.
- Possibility of interconnection and synchronization of up to 8 devices by LAN, managed from a single control.

Ecodesign of condensing units

Regulation (EU) 2015/1095 establishes a series of Ecodesign requirements. For condensing units up to 5 kW and 2 kW in PT and NT respectively, a minimum value requirement is established for the coefficient of performance COP, while for higher power unit the requirement refers to a normalized seasonal performance SEPR.

At INTARCON we have redesigned our product range to adapt to the Ecodesign directive, incorporating energy efficiency technologies, electronic motor fans and floating condensation control.

Variable Refrigerant Capacity

VRC system



Multi-service version, featuring VRC system (Variable Refrigerant Capacity), of refrigeration capacity regulation, applicable to hermetic alternative compressors, consisting of:

- ▶ Suction pressure valve (VP).
- ▶ By-pass pressure valve (VC).
- ▶ Thermostatic expansion valve for liquid injection (VE).
- ▶ Pressure control switch (IP).
- ▶ Built-in oil separator.

Multi-service versions of condensing units:

- ▶ Horizontal axial or centrifugal multi-service version.
intarbox-multi: MDH-CV/-V series.
- ▶ Horizontal axial low-noise multi-service version.
Sigilus-multi: MDF-V series.

Scheme

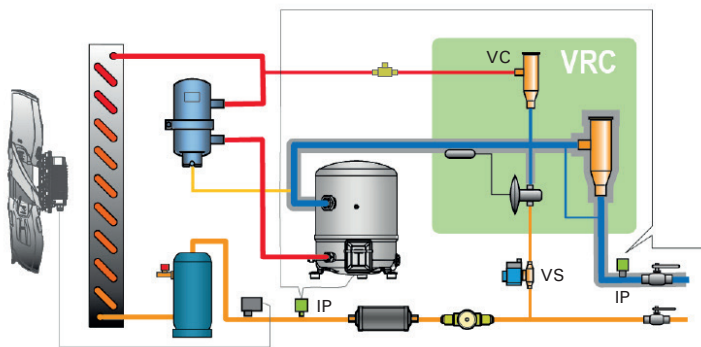

Example of multi-service installation

Units specifically designed for the centralisation of cooling production of several evaporators.

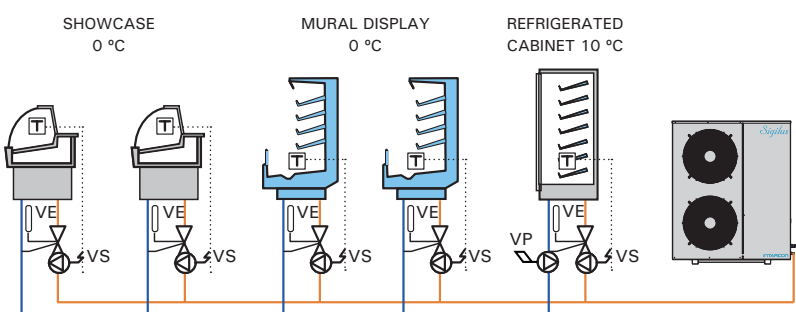

- ❄ Cooling capacity regulation.
- ❄ Constant evaporation pressure.
- ❄ Set services refrigeration production centralization.

VRC system is composed of a set of pressure and temperature valves capable of progressive variation of a compressor's cooling capacity between 100 % and 10 % of this rated power, at the same time the system reduces electrical input power and protects the compressor, maintaining its compression ratio within security margins, eliminating the risk of overheating.

VRC system: Variable Refrigerant Capacity

VRC system applied to a reciprocating hermetic compressor adjusts the flow of refrigerant to the evaporator unit's demand by maintaining constant pressure in the suction line.

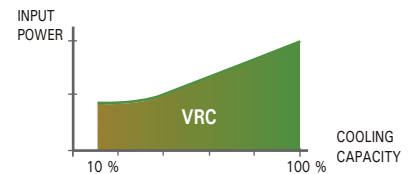

VRC system is characterized by:

- Consisting exclusively of high reliability mechanical components.
- Keeps the evaporation pressure constant.
- Protects the compressor against the risk of engine overheating.
- Maintains the compression ratio of the compressor within the safety limits.

Condensing units equipped with VRC system allow centralizing the refrigeration production of a set of services, maintaining constant the pressure and temperature of the refrigerant in the evaporators.

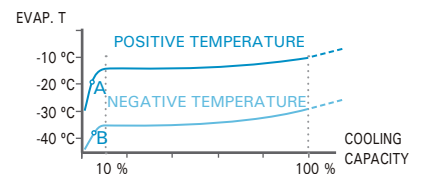

VRC system can be easily regulated to set a minimum evaporation pressure. The factory setting provides the following minimum evaporation temperatures:

- Positive temperature units: -13 °C
- Negative temperature units: -35 °C

With demand below 10 % of the nominal power, the characteristic of the evaporation pressure curve falls towards the minimum value admitted by the compressor, disconnecting the low pressure switch (points A and B) and stopping the compressor.

In this way, the multi-service condensing units are designed for low-pressure stop / start control (drop down or pump down).

Alternatively, the compressor running stop can be done through an external open / closed contact.

Electronic regulation

All our units incorporates state-of-the-art electronic controls, which ensures the safety of the cold room and care for the environment and the refrigeration equipment.

Features / Control	XM670K	XW270K	XH240K	XW60LH
Standard	Split systems	Monoblocks	With humidity control	R-290 monoblocks
Cold room temperature control	●	●	●	●
Digital control of condensing temperature	●	●		●
Cold room relative humidity control			●	
Time and temperature fast cooling cycle	●			
Time and temperature defrost cycle	●	●		●
Stop control with gas collection (pump-down)	●			
Energy save night operating mode	●	●		●
Time program with internal clock	●			
Digital condensing temperature control (2 speeds)	●	●		●
Proportional control of condensation with floating set-point	●			
Door opening contact	●	●		●
Recording of maximum and minimum temperatures		●		●
Maintenance quick access menu	●			
Available additional functions:	●	●		●
- Cold room light	●	●		●
- External alarm	●	●		●
- Heating resistance control	●	●		
- Safety heating	●	●		
- Liquid injection (split system at NT with R-449A)	●	●		
- Ventilation control	●			
Units synchronization	●			

Complete features of electronic controllers available at: www.intarcon.com

Self-diagnosis

The new XM electronics incorporate advanced self-diagnostic algorithms to detect anomalous operation, such as ice accumulation in the evaporator, or lack of gas. It also detects component malfunctions (defrosting resistors, fans or compressor) or probe failures, in anticipation of a potential break in the cold room.

XM670K

Standard control of:

- SH / SF / DH / DF / DM / HF



XW270K

Standard control of:

- CR / CV (except CV-L)



XH240K

Standard control of:

- HSF / VSF / VSH / VCR



XW60LH

Standard control of:

- CV-L / CP



Supervision and control system specialized in refrigeration and HVAC installations:

- ▶ Plug & Play installation.
- ▶ Compatible with all brands.
- ▶ Hyper-connectivity (Wifi, 3G or Ethernet).
- ▶ Secure cloud data storage.

Real time remote control of the installation.

Alarms management and sending.

Historical temperatures recording.

Remote assistance for problem analysis.



kiconex features:

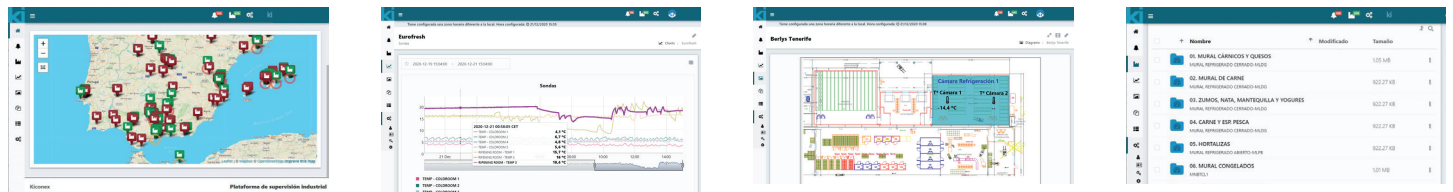

- ▶ Geolocation of installations.
- ▶ Multiple devices.
- ▶ Layout and installation synoptic.
- ▶ See parameters in real time.
- ▶ Temperatures and data history.
- ▶ Values recovery.
- ▶ Multi-user with access profiles.
- ▶ Smart programming.
- ▶ Units manuals and schematics.

kiconex service packages: we propose three service packages depending on the size of the installation to be controlled and the functions and features available.

	Basic	Professional	Premium
Device number	s/plan	s/plan	s/plan
Data history	3 months	1 year	3 years
Number of users/groups	1	3	No limit
Units configuration	●	●	●
Online update	●	●	●
Graphics design	●	●	●
Alarm display	●	●	●
Documentation display	●	●	●
Diagrams design		●	●
Alarm design		●	●
Documentation design		200 Mb	1 Gb
Extra libraries design		1 extra	5 extra
Rules design			●
kiconex 2 (2 devices)	600 €	1 000 €	1 500 €
kiconex 8 (8 devices)	1 000 €	1 500 €	3 000 €
kiconex 16 (16 devices)	1 200 €	2 000 €	4 000 €
kiconex 32 (32 devices)	1 500 €	3 000 €	5 000 €
Wire 100 m 2 x 1 mm		160 €	
kiconex board 350 x 300		350 €	
kiconex board 400 x 400		400 €	
Router WiFi / 3G		400 €	
kiwi (kiconex wireless)		180 €	

kiconex modules

kiBox data acquisition module:
Connection to devices via ModBUS RTU protocol in RS485 network (2 wires) or TCP-IP. Connection to cloud server via Ethernet, 3G / 4G or Wifi modem.



kiwi wireless network module:



RS485 - Wifi link.

Package dimensions

Series	Model	Standard packaging (road transport)						Reinforced packaging (marine transport)						
		Package dimensions (mm)			Package/s dimensions (mm)			Package dimensions (mm)			Package/s dimensions (mm)			
		Length	Width	Height	Length	Width	Height	Length	Width	Height	Length	Width	Height	
Monoblocks	intartop	CR - 0	860	665	640	-	-	-	900	705	700	-	-	-
		CR - 1	920	820	725	-	-	-	960	860	785	-	-	-
		CR - 2	980	920	810	-	-	-	1 020	960	870	-	-	-
		CR - 3	1 230	1 050	980	-	-	-	1 270	1 090	1 040	-	-	-
		CP - 0/1	1 070	940	590	-	-	-	1 110	980	650	-	-	-
		CV - L - 0	620	435	990	-	-	-	660	475	1 050	-	-	-
		CV - L - 1	765	435	990	-	-	-	805	475	1 050	-	-	-
	intarblock	CV - 0	600	450	840	-	-	-	640	490	900	-	-	-
		CV - 1	1 095	650	1 050	-	-	-	940	475	1 080	-	-	-
		CV - 2	1 095	650	1 050	-	-	-	940	690	1 110	-	-	-
		CV - 3	895	760	1 080	-	-	-	935	800	1 140	-	-	-
		CV - I - 1	900	430	1 195	-	-	-	940	470	1 255	-	-	-
		CV - I - 2	900	650	1 360	-	-	-	940	690	1 420	-	-	-
		CV - I - 3	890	760	1 390	-	-	-	930	800	1 450	-	-	-
Split systems	intarsplit	SH-N - 0/00	720	480	750	-	-	-	760	520	810	-	-	-
		SH-N - 1/11	805	510	820	-	-	-	845	550	880	-	-	-
		SH-N - 2/22	1 080	550	900	-	-	-	1 120	590	960	-	-	-
		SH-N - 3/33	1 035	670	700	1 790	595	400	1 075	710	760	1 830	635	460
		SH-N - 4/43/44	1 165	690	740	1 790	595	400	1 205	730	800	1 830	635	460
		SH-N - 44	1 165	690	740	2 170	650	440	1 205	730	800	2 210	690	500
		SH-Q - 30	1 035	670	700	930	650	770	1 075	710	760	970	690	830
		SH-Q - 40	1 165	690	740	930	650	770	1 205	730	800	970	690	830
		SH-Q - 41	1 165	690	740	1 270	650	740	1 205	730	800	1 310	690	800
		SH-Q - 42	1 165	690	740	1 660	650	740	1 205	730	800	1 700	690	800
		SH-Q - 52	1 475	815	820	1 660	650	740	1 515	855	880	1 700	690	800
		SH-Q - 53	1 475	815	820	1 970	650	740	1 515	855	880	2 010	690	800
		SH-Q - 54	1 475	815	820	2 670	650	840	1 515	855	880	2 710	690	900
		SH-D - 1/11	850	830	980	-	-	-	890	870	1 040	-	-	-
		SH-D - 2014 up to 2018	995	820	980	-	-	-	1 035	860	1 040	-	-	-
		SH-D - 2/22	995	820	1 220	-	-	-	1 035	860	1 280	-	-	-
	SH-D - 3/33	1 035	670	700	1 790	910	500	1 075	710	760	1 830	950	560	
	SH-D - 4/43	1 165	690	740	1 790	910	500	1 205	730	800	1 830	950	560	
	SH-D - 44	1 165	690	740	2 190	1 000	550	1 205	730	800	2 230	1 040	610	
	SF-N - 0/00	730	500	835	-	-	-	770	540	895	-	-	-	
	SF-N - 1/11/2/12	1 170	520	990	-	-	-	1 210	560	1 050	-	-	-	
	SF-N - 3/13	1 160	445	730	1 790	595	400	1 200	485	790	-	-	-	
	SF-N - 4/23	1 220	480	970	1 790	595	400	1 260	520	1 030	1 830	635	460	
	SF-N - 24	1 220	480	970	2 170	650	440	1 260	520	1 030	2 210	690	500	
	SF-N - 34	1 310	550	1 270	2 670	650	840	1 350	590	1 310	2 710	690	900	
	SF-Q - 10	1 160	445	730	930	650	770	1 200	485	790	970	690	830	
	SF-Q - 20	1 220	480	970	930	650	770	1 260	520	1 030	970	690	830	
	SF-Q - 21	1 220	480	970	1 270	650	740	1 260	520	1 030	1 310	690	800	
	SF-Q - 22	1 220	480	970	1 660	650	740	1 260	520	1 030	-	-	-	
	SF-Q - 32	1 310	550	1 250	1 660	650	740	1 350	590	1 310	-	-	-	
	SF-Q - 33	1 310	550	1 250	1 970	650	740	1 350	590	1 310	-	-	-	
	SF-Q - 34	1 310	550	1 250	2 670	650	840	1 350	590	1 310	-	-	-	
SF-Q - 43	1 340	580	1 500	1 970	650	740	1 380	620	1 560	-	-	-		
SF-Q - 44	1 340	580	1 500	2 670	650	840	1 380	620	1 560	-	-	-		
SF-D - 1024 up to 1018/11	1 160	775	910	-	-	-	1 200	815	970	-	-	-		
SF-D - 1024 up to 1034/12	1 160	750	1 220	-	-	-	1 200	790	1 280	-	-	-		
SF-D - 1038/13	1 160	445	730	1 790	910	550	1 200	485	790	1 830	950	610		
SF-D - 14	1 160	445	730	2 190	1 000	550	1 200	485	790	2 230	1 040	610		
SF-D - 2/23	1 220	480	970	1 790	910	500	1 260	520	1 030	1 830	950	560		
SF-D - 24	1 220	480	970	2 190	1 000	550	1 260	520	1 030	2 230	1 040	610		
SF-D - 3	1 310	550	1 250	1 790	910	500	1 350	590	1 310	1 830	950	560		
SF-D - 34	1 310	550	1 250	2 190	1 000	550	1 350	590	1 310	2 230	1 040	610		
SF-D - 4/44	1 340	580	1 500	2 190	1 000	550	1 380	620	1 560	2 230	1 040	610		
VSF / VSH - 0/00	870	700	800	-	-	-	910	740	860	-	-	-		
VSF / VSH - 10	1 160	750	800	-	-	-	1 200	790	860	-	-	-		
VSF / VSH - 11/1014	1 160	750	890	-	-	-	1 200	790	950	-	-	-		
VSF / VSH - 12/1024/1034	1 160	750	1 220	-	-	-	1 200	790	1 280	-	-	-		
VSF / VSH - 2/23	1 220	480	970	1 790	975	395	1 260	520	1 030	1 830	1 015	455		
VSF / VSH - 3/33	1 310	550	1 250	1 790	975	395	1 350	590	1 310	1 830	1 015	455		
intarsANIT	TCH - 1	1 560	1 030	650	-	-	-	1 600	1 070	710	-	-	-	
	TPD - 3	1 700	950	600	-	-	-	1 740	990	660	-	-	-	
	TPD - 6	1 700	1 680	600	-	-	-	1 740	1 720	660	-	-	-	

Series	Model	Standard packaging (road transport)						Reinforced packaging (marine transport)						
		Package dimensions (mm)			Package/s dimensions (mm)			Package dimensions (mm)			Package/s dimensions (mm)			
		Length	Width	Height	Length	Width	Height	Length	Width	Height	Length	Width	Height	
Waterloop system	CC - 0	1 590	600	650	-	-	-	1 630	640	710	-	-	-	
	CC - 1	1 890	600	680	-	-	-	1 930	640	740	-	-	-	
	DM - 0	600	500	380	-	-	-	640	540	440	-	-	-	
	DM - 1	1 000	420	680	-	-	-	1 040	460	740	-	-	-	
	DM - 2	1 170	450	760	-	-	-	1 210	490	820	-	-	-	
	CWF - 0 / 1	1 190	440	720	-	-	-	1 230	480	780	-	-	-	
	CWF - 2	1 220	480	970	-	-	-	1 260	520	1 030	-	-	-	
	CWF - 3	1 310	550	1 250	-	-	-	1 350	590	1 310	-	-	-	
	CWF - 4	1 340	580	1 500	-	-	-	1 380	620	1 560	-	-	-	
	CWF - 6	1 900	580	1 250	-	-	-	1 940	620	1 310	-	-	-	
Condensing units	intarbox	DH - 0	720	480	500	-	-	-	760	520	560	-	-	-
		DH - 1	810	510	560	-	-	-	850	550	620	-	-	-
		DH - 2	995	515	650	-	-	-	1 035	555	710	-	-	-
		DH - 3	1 035	670	700	-	-	-	1 075	710	760	-	-	-
		DH - 4	1 165	690	740	-	-	-	1 205	730	800	-	-	-
	Sigillus	DH - 5	1 475	815	820	-	-	-	1 515	855	880	-	-	-
		DF - 0	730	365	565	-	-	-	770	405	625	-	-	-
		DF - 1	1 160	445	730	-	-	-	1 200	485	790	-	-	-
		DF - 2	1 220	480	970	-	-	-	1 260	520	1 030	-	-	-
		DF - 3	1 310	550	1 250	-	-	-	1 350	590	1 310	-	-	-

Sales terms

Except in case of agreement with INTARCON, the following general sales terms prevail.

Price

The prices indicated in this list, except for typographical errors, are retail prices with cash payment, do not include VAT or indirect taxes, and will remain in force during the period of validity of this catalogue or until a new edition.

Installation

The buyer admits that INTARCON's products are capital goods for integration in a refrigeration installation. To that effect, the buyer assumes obedience to any applicable law and to guarantee the quality of the installation, which, in any case, is to be done by an authorised installer.

Orders

The orders are to be placed in writing and to be confirmed by the seller through a pro forma invoice indicating the shipping date. The seller reserves the right to refuse an order. Once manufacturing has started, no cancellations will be accepted.

Packaging

Prices include standard packaging for road transport, not suitable for overseas transport.

Delivery

The delivery of INTARCON goods is according to FCA INTARCON (PI Los Santos, 14900 Lucena - Spain) according to Incoterms 2010 of the ICC. The only accepted delivery claims are those received in written on the delivering note within 24 hours from the delivery.

Refunds

No refunds will be accepted without prior authorisation from the manufacturer and, in any case, an amount no less than 10 % of the purchasing price will be deducted as a return cost.

Technical-features

The information and features in this catalogue are given as an indication, technical data can be changed with no prior communication, and should be confirmed when placing an order.

Warranty

The seller guarantees the product against any manufacturing default for 12 months from delivering date.

During the warranty period the manufacturer will cover the repair of the product in its facilities, the replacement of the product or the supply of spare parts for defective components, which is less burdensome and technically feasible. The cost and taxes on the refrigerant are expressly excluded from the warranty coverage when it has not been supplied by the manufacturer in hermetically sealed appliances. The warranty does not cover on-site labour for the replacement of the product or spare parts, nor the indirect damages or consequential losses that may be attributed to the malfunction of the product. Specifically, the manufacturer may not be responsible for the Tax on Fluorinated Gases stipulated in Law 16/2013, emitted into the atmosphere as a result of a leakage of a refrigeration unit subject to a tightness and resistance test by the refrigeration installer and a periodic leak control according to Regulations 517-2014 on F-Gas and Safety for Refrigeration Installations, RD 138/2011.

Payment

Unless agreement with the manufacturer, the payment of the invoices will be in cash. The seller of the goods reserves the right to block delivery of the orders in the case that any risk in payment is perceived.

Lawsuits

INTARCON's product trade is ruled by Spanish laws. Any conflict or argument is to be submitted to the judgment of the Córdoba Chamber of Commerce. In case of disagreement, both parties will relinquish to any jurisdiction to which may pertain and they will submit to the Court of Lucena (Córdoba) Spain.

2021 II edition - 250313

Rate effective from the 1st of July 2021 until new edition.
Price list update. Edited by INTARCON.

Total or partial reproduction of this catalogue is prohibited without the express authorization of the author.

www.intarcon.com



Industrias de Tecnologías Aplicadas de Refrigeración y Conservación, S.L.
CIF B14779136
P.I. Los Santos, Bulevar de Los Santos 34 | 14900 Lucena (Córdoba) - Spain
+34 957 50 92 93 | commercial@intarcon.com